

REV.	DATE	ECO	DESCRIPTION	BY	CK	APP
A	6/13/2025	17686	INITIAL RELEASE	BM	N/A	SEE ECO

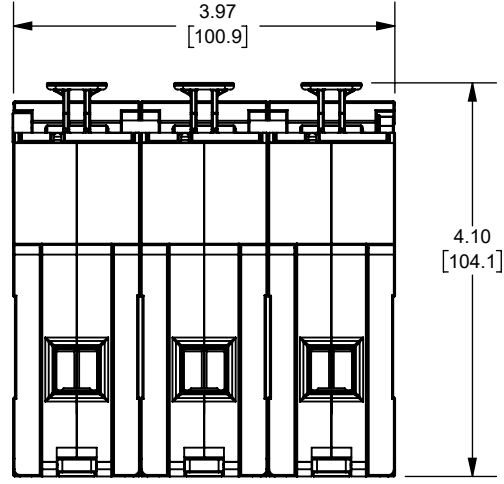
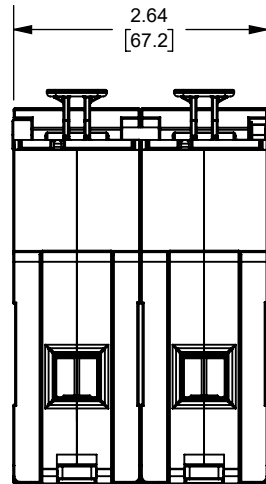
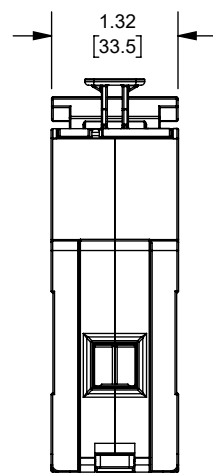
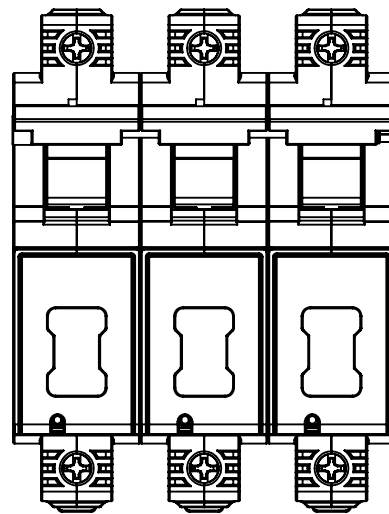
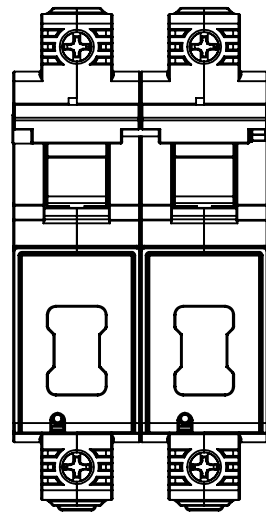
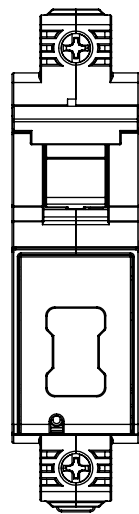

FS30J1

FS30J2

FS30J3

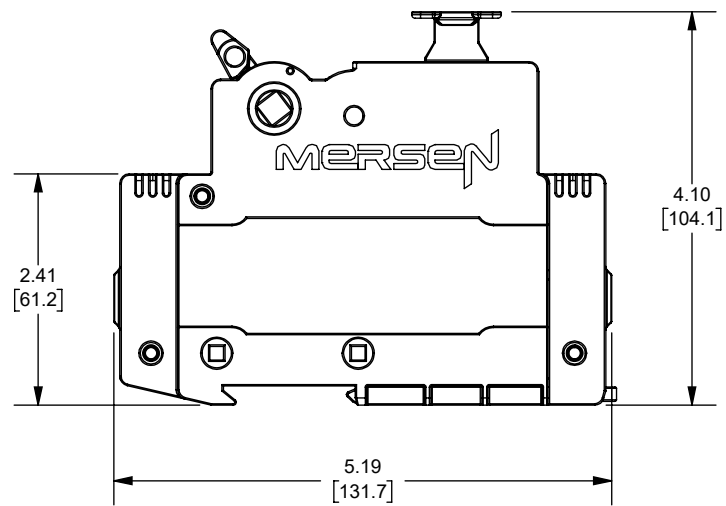

OUTLINE DIMENSIONS
NOT TO BE USED FOR PRODUCTION
DIMENSIONS IN []
ARE MILLIMETERS

Approval stage / Etat d'approbation: APPROUVÉ POUR FABRICATION / APPROVED FOR MANUFACTURING		Product Class:/ Product Type: CLASS J FUSED DISCONNECT SWITCH	
Initial ECO / ECO initiale:		Product amp rating:/ Voltage rating: 30A 600V	
Draw by / Dessiné par: Brianda MARTINEZ		Date : 6/16/2025	
Checked by / Vérifié par: Yadyra Fang		Date : 6/16/2025	
Electrical Power 374 MERRIMAC STREET NEWBURYPORT, MA 01950		Éch / Scale : 2:4 Format / Size : B	
Title / Titre: OUTLINE FS30J(1-3)		Weight : Masse :	
Drawing / de dessin: OUT-1209464		Rev : Rév : A	
Part / Article: SEE TABLE		Page : 1/1	

FS30J3
FS30J2
FS30J1
CATALOG NUMBER



Ce plan strictement confidentiel est la propriété exclusive de la société MERSEN sans l'autorisation écrite de laquelle il ne peut être ni reproduit, ni copié, ni communiqué à des tiers.
This drawing and specifications there on is property of MERSEN and shall not be reproduced or copied or used in whole or in part as the base for manufacture or sale of item without written permission.