

REV.	DATE	ECO	DESCRIPTION	BY	CK	APP
-	01/16/12	N/A	INITIAL RELEASE	GDR	N/A	N/A

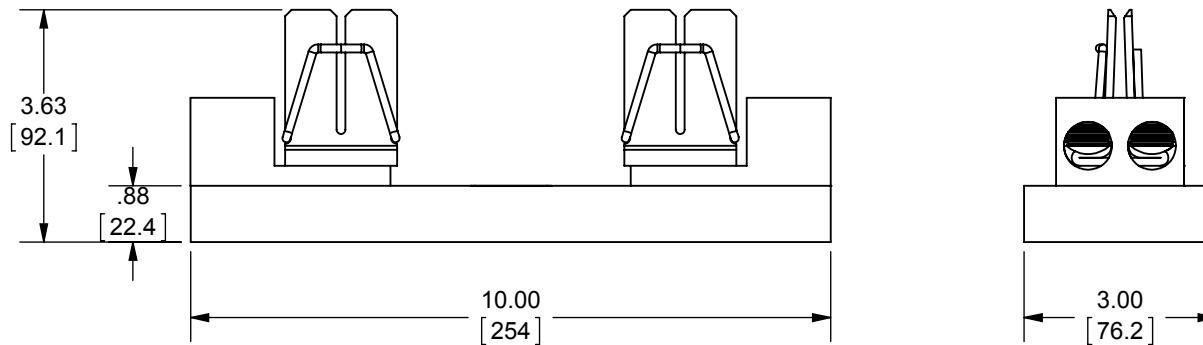

DIMENSIONS IN [] ARE MILLIMETERS

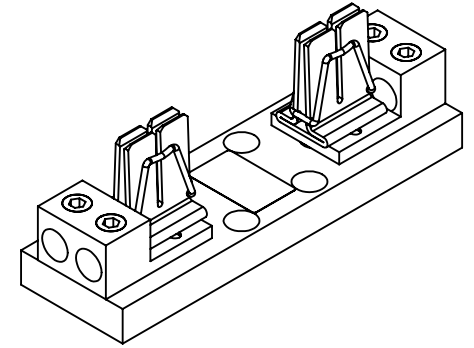
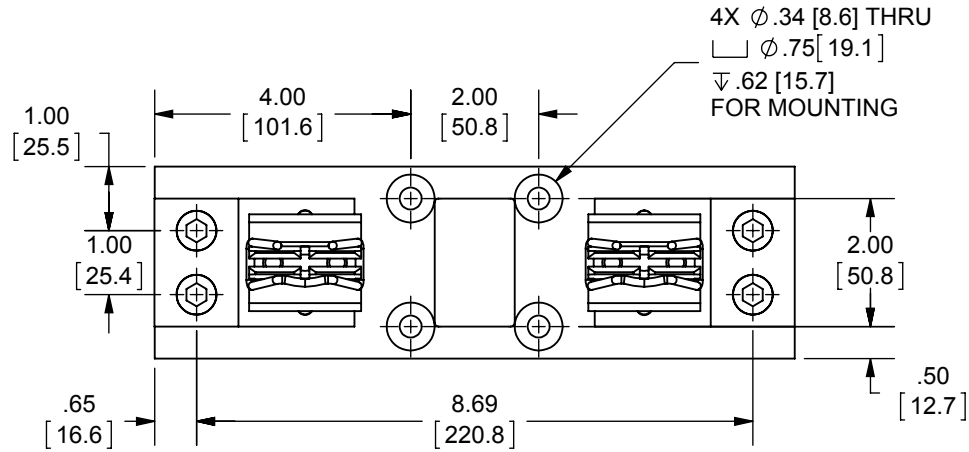

MERSEN USA NEWBURYPORT-MA, LLC
 374 MERRIMAC STREET
 NEWBURYPORT, MA 01950

64031HPJ
 PHOTOVOLTAIC FUSEHOLDER

OUTLINE DIMENSIONS
 NOT TO BE USED FOR PRODUCTION

PRODUCT MANAGER

DESIGN ENGINEER

SIGN:

SIGN:

DATE:

DATE:

CLASS J 1-POLE
 1000VDC 400A

701841