

OBSERVATION OF ARCING INSIDE A FUSE UNDER CAPACITOR DISCHARGE USING 5 MILLION FRAMES PER SECOND X-RAY IMAGING

POWER ELECTRONICS PROTECTION NOTE 7

BY JEAN-FRANÇOIS
DE PALMA AND
JEAN-LOUIS GELET

ACKNOWLEDGMENTS

The authors would like to sincerely thank all contributors to the experiments which led to the production of this paper. At first their gratitude goes to Alexander Rack and Margie Olbinado from ESRF in Grenoble for their very professional way to solve the requirements of the experiments. They also would like to thank Xavier JUST, PhD student, and Pierre Luissier, researcher at the SIMAP-lab in Grenoble, who initiated the rapprochement with the ESRF. Many thanks also to Jean-Marc Chaix and Rémy Dendievel from the SIMAP-lab in Grenoble and Olivier Bonnefoy and Gérard Thomas from ECOLE des MINES in Saint-Etienne who brought their large amount of scientific and technological skills about granular media. In addition, the work carried out by Mathieu Morati, from Mersen's R&D team, for the design and the construction of the test-equipment will be highlighted.

ABSTRACT

Despite their apparent banality, fuses are still obligatory components in modern electrical equipment by offering the ultimate protection against faulty conditions and guaranteeing the disconnection of the damaged legs. Melting of the conducting wire is not as intricate as cancellation of the current by the electrical arc occurring during fuse operation. Generations of engineers and scientists investigated for understanding complex phenomena related to interaction between arc and sand arranged as energy absorbent. Most of their observations have been run post mortem. All had the dream to make the actual movie of an arc inside the fuse envelope. A few of them approached this fantasy by using diverting ways such as spectroscopy through a window or matrix of magnetic sensors. Unfortunately that gave deficient information. For the first time a team from Mersen, together with researchers from SIMAP-laboratory at the University of Grenoble took profit of the facilities of the ESRF-synchrotron also in Grenoble to proceed to ultra-fast X-ray imaging of the arc inside the envelope. Observations up to 5,000,000 frames per second have been

KEYWORDS

- **DC power supply**
- **Voltage Source Inverters (VSI)**
- **Measurement**

OBSERVATION OF ARCING INSIDE A FUSE UNDER CAPACITOR DISCHARGE USING 5-MILLION FRAMES PER SECOND X-RAY IMAGING

performed. Analysis of the records brings valuable information about the arc in the fuse and allows adjusting models, with a major interest for very fast operation under high di/dt .

1. INTRODUCTION

Fuses are one of the oldest components of the electrical technology. As soon as engineers made use of electricity for practical applications, they met problems with over-currents and they found solutions with fuses [1]. Without the safe protection of the electric fuses, Electricity would be probably regarded as far too dangerous for widespread use and there would be no modern electrical industry [2]. Also, a fuse is generally considered as a very simple device, most of the people keeping in mind that when the heating is too high, the fuse melts. But things are not so evident. A fuse has to fulfill two main functions: conduction and breaking, breaking consisting itself in two phases - arcing and pre-arcing. Due to Joule's effect heating occurs during conduction. Both electrical and thermal equations are well-known and can be easily coupled, especially with nowadays soft-wares and the power of modern computers. Pre-arcing also calls in coupling between electrical and thermal phenomena, with the difference that a large range of temperature is covered, binding to take into account variations of physical characteristics such as electrical and thermal resistivities. Arcing is much more difficult to consider. Of course, for decades, engineers and researchers have developed many studies and proposed a lot of models. But except in very specific cases where diverse methods have been used, only *post-mortem* observations were

available and anyone remains with the dream to see the arc inside the fuse in order to approach its dynamics. For the first time, a team researchers run tests and recorded movies of the arc into the envelop, using ultra-fast X-ray imaging. Thanks to their very high frequencies, the films carried out at ESRF allow visualizing how the conductive material turns from a solid-liquid phase to an embryo of plasma. At the end of this transition, conditions are fulfilled for the arc to grow in section and length. Also, the end of this transition corresponds to the initial conditions for usual modeling of the arcs. On another hand the movies give access to the burn-back. By synchronizing pictures with electric parameters, i.e. voltage and current, a large amount of information becomes available. In this paper, we have chosen to take into consideration calculations of the electric field E in the arc-plasma and to compare the curves $E(i)$ to the data in the literature.

2. ELECTRICAL ARCING IN A FUSE IS A VERY DYNAMIC PHENOMENON

In the rest of this text, we will not take into account the conduction function anymore and we will focalize upon breaking, and more specifically on arcing. After melting of the metallic conductor, current is not instantaneously turned to zero. During this period the transfer of electrical charges through the fuse goes on. The medium that insures this transfer is an electric arc. Figure 1 compares the operation of a fuse under maximal energy conditions according to IEC 269.1 for AC voltage at 50 Hz. and the operation under VSI-conditions.

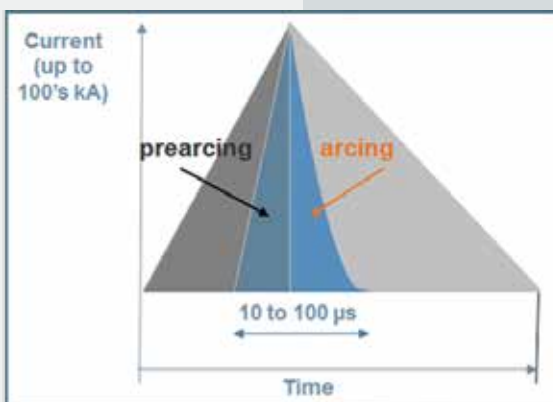
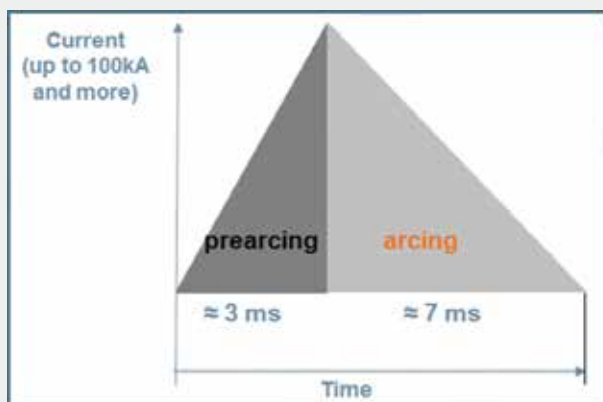

Figure 1- Current-curve for prearcing and arcing periods. Left : Principle-graphic of breaking at I_2 -current according to IEC 269.1 standard. Right : Principle graphic for VSI-short circuit.

OBSERVATION OF ARCING INSIDE A FUSE UNDER CAPACITOR DISCHARGE USING 5-MILLION FRAMES PER SECOND X-RAY IMAGING

For example, a fuse rated at 1000A and 690V, operating under IEC 60-260-1 I2 conditions, will have to manage an arc-energy reaching typical values of about 100 kJ by ensuring the transfer of this energy to the surrounding medium. Because of the high values of specific heat, melting temperature and latent melting heat of silica, only a reduced volume of material is needed, in opposition with what would happens in air or vacuum. From its ignition, the arc propagates through the sand according to a continuous process. Figure 2 hereunder is a sketch of what is supposed to occur.

Generations of engineers and scientists have investigated to understand complex phenomena related to interaction between arc and sand arranged as energy-absorbent. Most of their observations have been run post mortem. All had the dream to make an actual movie of an arc inside the fuse-envelope. A few of them approached this fantasy by using diverting methods such as spectroscopy through a window or a matrix of magnetic sensors. Nevertheless, despite deficient information, very relevant conclusions have been drawn out. W. Bussi re [3] built an experiment around special fuses fitted with a window allowing observing and making records with a fast-camera at 35,000 frames per second. He could measure the burnback-rate during AC-operations. Unfortunately the experiments were biased as the energy-absorbent medium did not fully surround the arc. Also, the rate of shooting seems to be sufficient as it offers 350 images for half a period at 50 Hz, but it remains low for looking at quicker phenomena such as the establishment of the arc-voltage and for operations under VSI-conditions.

3. X-RAY IMAGING AT 5.10⁶ FRAMES PER SECOND

For the first time a team of engineers from Mersen and researchers from Grenoble-INP and Ecole des Mines de St-Etienne have done ultra-fast X-ray imaging of the arc across the envelope. Observations up to 5,000,000 frames per second have been performed [4]. Analysis of the records brings valuable information about the arc in the fuse and allows adjusting models, with a major interest for very fast operation under high di/dt.

For the experiments, the fuse is included in the discharging circuit of a capacitor, this capacitor being previously loaded to the required voltage by a DC supply. Discharging conditions are adjusted by the inductance of a wiring cable. The fuse is illuminated by a parallel X-ray beam whose energy was previously tuned according to the absorbance of the materials integrated in the fuse-sample. The image is formed on a scintillator that transforms information from X-ray to visible light. This image is captured by a CCD-camera in the back of a lens in order to adapt the magnification. The synchronization of the beam-opening, of the closing of the discharging circuit and of the CCD-camera shooting is ensured by a programmable microcontroller.

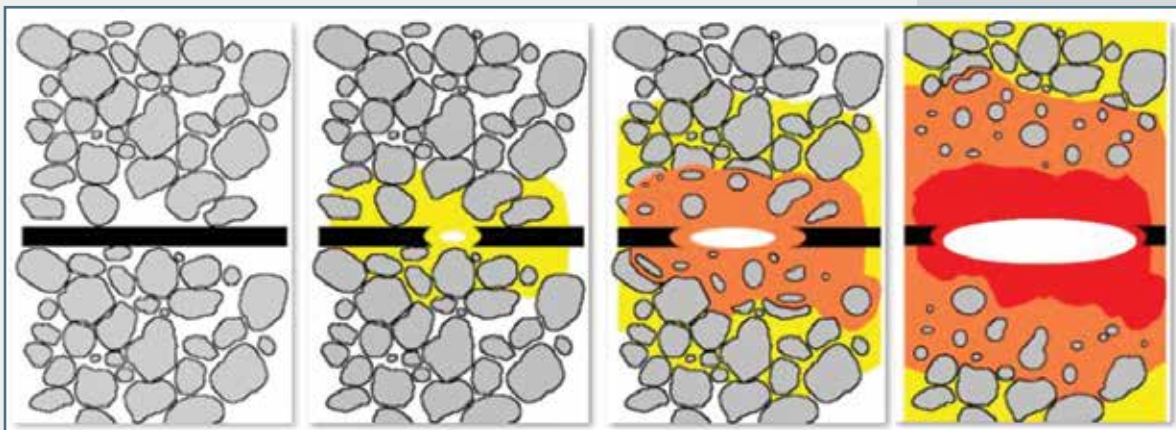

Figure 2 : 4-pictures description of the continuous phenomenon of an arc in granular medium.

OBSERVATION OF ARCING INSIDE A FUSE UNDER CAPACITOR DISCHARGE USING 5-MILLION FRAMES PER SECOND X-RAY IMAGING

Table 1 : Testing Circuit Components	
X-ray source	ESRF (European Synchrotron Radiation Facility) in Grenoble. Line ID19
Scintillator	LYSE : Ce 550 mm thick
CCD (Charge-Coupled Device) Camera	SHIMATZU HPV-X2
Microcontroller	ARDUINO UNO
Capacitor	3 // SIC-SAFCO Felsic DI 2200 µF 480 Vdc
Switch for circuit closing	2 // thyristors SEMIKRON SKT 40 14E
DC-supply for capacitor charging	KEITHLEY 247 High Voltage Supply
Current and voltage recording	AGILENT Technology DSO-X 2004A
Current probes	Rogowski Coil
Voltage probes	KEITHLEY

A first signal is given to the shutter of the chamber for opening the X-ray-beam, with a delay of 100 ms to be sure its opening is achieved. Then three signals are sent simultaneously to:

- The acquisition of electrical signals by the oscilloscope
- The opening of the shutter of the CCD-camera and the beginning of the acquisition of the images
- The capacitor discharge

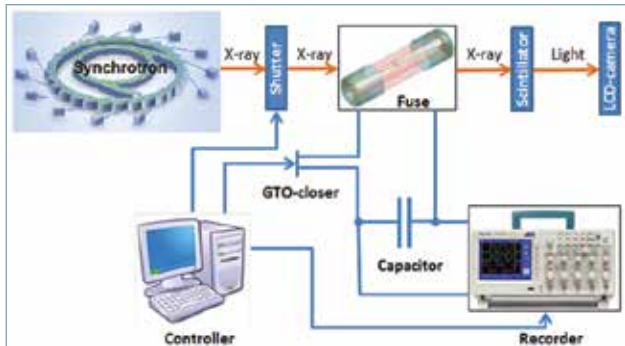

Figure 3: Simplified organization of the test equipment, showing its principal parts

The test samples were cylindrical fuses (diameter 10 mm, length 38 mm) from Mersen’s commercial range. They are gR-class, with 20A nominal current rating and 690V nominal operation voltage.

The protocol for experiments consists in testing samples under several electrical conditions (voltage, length of the loop of the circuit), setting the fuse element so that it presents its edge or its surface toward the X-ray beam, and finally under different shooting frequencies. Indeed, the memories of the CCD-camera allow recording only 128 frames. Then, depending on whether the whole arcing is to be recorded or only the beginning of the arc, it will be necessary to adapt the acquisition frequency. At 1 frame for 100 microseconds, it will be possible to record all the duration of the arc. Higher frequencies, such as 1 frame for 0.2 microseconds will be used for focusing on the transition from prearcing to arcing and the first moments of the arc. Good repeatability of fuse operation allows optimizing acquisition of information, by reproducing several times the same electric conditions under different shooting frequencies and for the two perpendicular positions of the fuse-element.

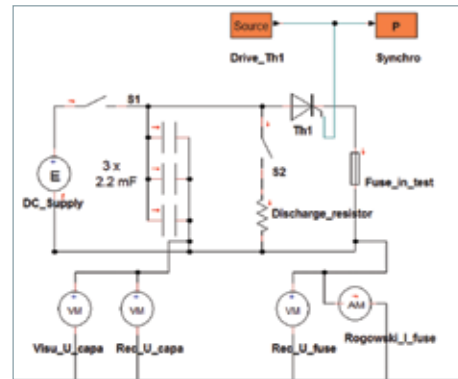

Figure 4: Electrical circuit

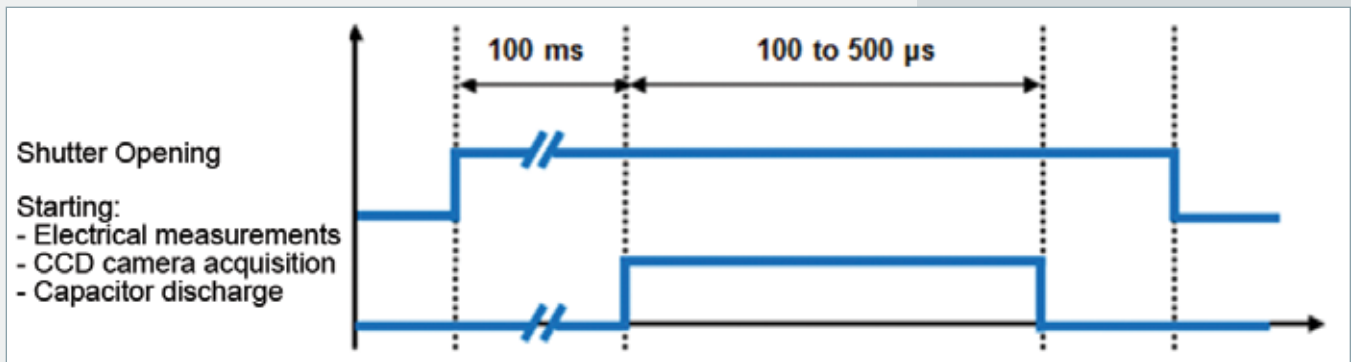

Figure 5 : sinogram for events synchronization

OBSERVATION OF ARCING INSIDE A FUSE UNDER CAPACITOR DISCHARGE USING 5-MILLION FRAMES PER SECOND X-RAY IMAGING

Table II: testing conditions	
Voltage	450 V / 400 V / 300 V
Current and di/dt	Short loop / Large loop
Position of the conductor towards X-ray-beam	edge / surface
Shooting-frequency	1 im./0,2 μsec. / 1 im./0,5 μsec. / 1 im./1 μsec. 1 im./2 μsec. / 1 im./5 μsec. / 1 im./10 μsec. 1 im./20 μsec. / 1 im./100 μsec. / 1 im./200 μsec.

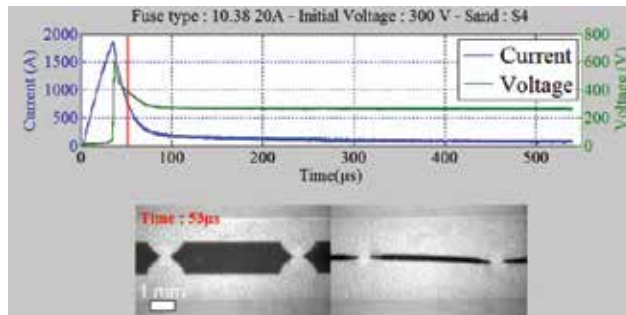

Figure 6: Synchronization of the current and the voltage with two pictures extracted from two different movies, one with the element seen on its flat surface, the other on its edge. In this case, for all curves and pictures, time is 53 μsec.

4. ANALYSIS OF THE OBSERVATIONS

For the same definition of the samples, i.e. same element width and thickness, same geometry of the constrictions, same sand and same compaction of the sand, and for the same electrical conditions, i.e. same voltage and same inductance, tests have been repeated for several shooting frequencies, in order to cover all the arcing period and get as much information as possible.

The first analysis concerned standard fuses tested under capacitor discharges at 300, 400 and 450 V with a short loop. Of course, it is possible to draw the curves of current and voltage across the fuse versus time.

Voltage curves show a sharp rise corresponding to the beginning of current decrease. In a very short time, conduction of electric charges passes from the metallic mode to the transfer in an electrical field between two electrodes. This transitional phase between the pre-arcing phase and the arcing phase is not considered in the publications to which we had access. Usually the authors define an initial condition that amounts to the assumption of an arc instantly reaching a non-zero initial length λ_0 , this arc spreading and lengthening later as current and voltage vary. Applying this hypothesis to the fuse means that the transition is instantaneous between pre-arcing and arcing, the initial arc having dimensions close to those of the constriction and ready to increase:

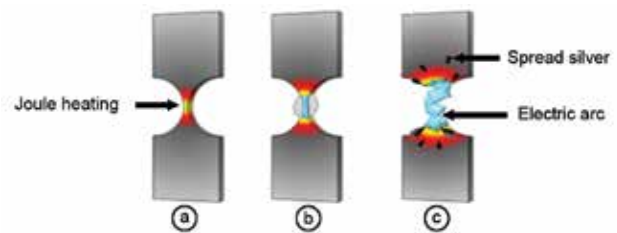

Figure 8: Generally, authors make the hypothesis that conduction goes directly from (a) to (c).

In a recent work, A. Coulbois [5] carried out a quasi-exhaustive approach of all the phenomena being liable to take part in the transition from prearcing to arcing. The most interesting seem to be internal nucleation, magneto-hydro-dynamics and surface vaporization. During the tests at ESRF, R-ray-films have been recorded at up to 1 frame per 0.2 micro-second. They make it possible to observe this transition from prearcing to arcing. Hereunder a series of pictures extracted from a film is given.

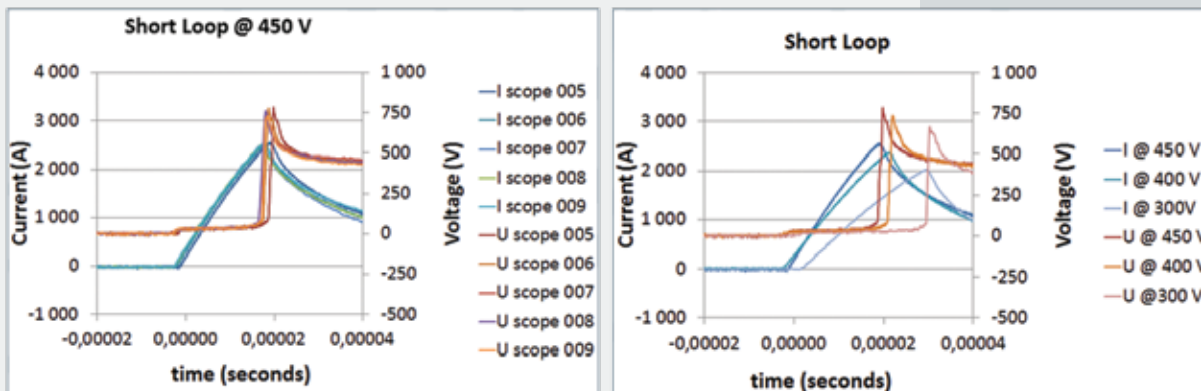

Figure 7: Curves of current and voltage. Left: five samples have been tested under 450 V and a short loop. Right: samples have been tested under 300, 400 and 450 V.

OBSERVATION OF ARCING INSIDE A FUSE UNDER CAPACITOR DISCHARGE USING 5-MILLION FRAMES PER SECOND X-RAY IMAGING

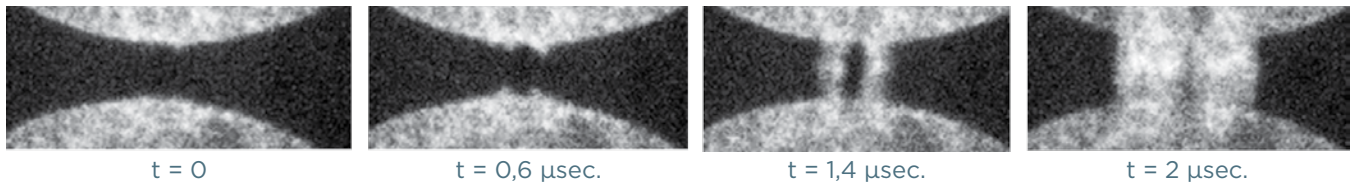

Figure 9: Series of pictures extracted from a film; shooting-frequency is 1 frame per 0.2 μsec.

At the beginning, the narrowest area of the constriction inflates and then gradually separates from both sides of the remaining conductor. This seems to corroborate the magneto-hydro-dynamic hypothesis.

But, for the time being, X-ray records have been taken into consideration for measuring the arc-length from the time t_0 it is actually established. Time t_0 is chosen as the instant of the first picture of the film where there is no more material between the two separated sides of the constriction. For example, in figure 9 above, the picture on the right, at $t = 2 \mu\text{sec}$, it has been considered that the arc is not completely established. Frame by frame, arc lengths have been measured for all the tests carried out on standard fuse samples under 300, 400 and 450 V with the short loop. For high shooting frequencies (1 frame/μsec and more), only the first instants of the arc are recorded; corresponding arc lengths are plotted on the left side of the graph hereafter. For low shooting frequencies (1 frame for 10 to 100 μsec.), the entire arc duration is recorded; corresponding arc lengths are plotted on the full width of the graph. All the points, recorded at both high and low shooting frequencies, have been fitted with a piecewise linear law in logxlog axes. These calculations have been run for the three voltages 300, 400 and 450 V. A

reference document about lengthening of the arc is the paper written by Turner and Turner [6] in 1977.

From the piecewise linear law, it becomes possible to evaluate arc length at any time and to compare it with electrical parameters, i.e. current and voltage.

Also it is possible to evaluate the value of the electrical field in the arc. It will be supposed that the field is homogenous within the arc column and the voltage at the electrodes will be estimated with equations from the literature. Authors like Dolegowski [7], Onuphrienko [8], and Wright and Beaumont [9] have proposed laws as follows:

$$U_{\text{electrodes}} = (20 \pm 5) + 1.5.[i(t)]^{0.39} \quad \text{Dolegowski}$$

For the following calculations, a model given by Gnanalingam and Wilkins [10] has been used:

$$U_{\text{electrodes}} = 15 + 1.0.[i(t)]^{0.39} \quad \text{Gnanalingam and Wilkins}$$

Consequently, the electrical field has been calculated according to the expression:

$$E = \frac{U_{\text{measure}} - 15 - 1.0.[i(t)]^{0.39}}{L_{\text{piecewise linear fitted}}}$$

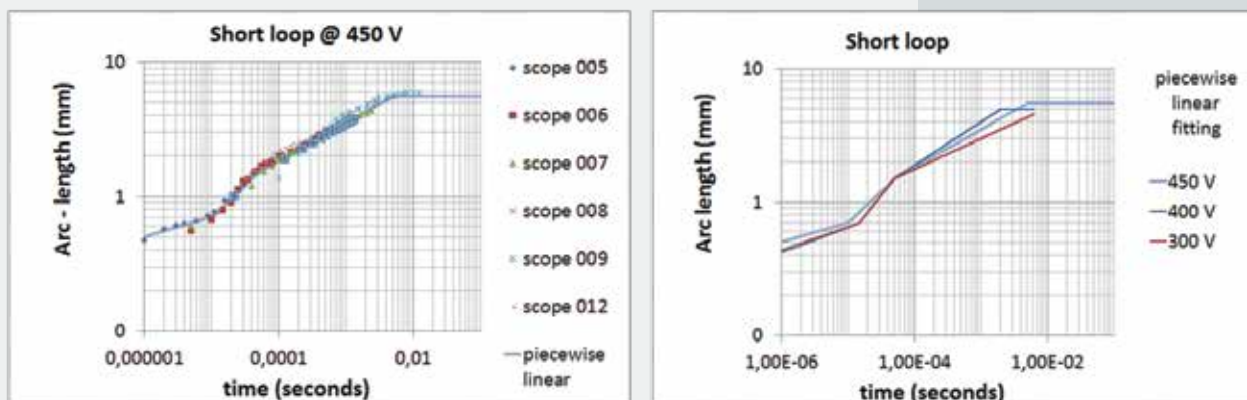

Figure 10: Arc lengthening measurements. Left: repeatability of tests under 450V for several shooting frequencies. Right: effect of the capacitor voltage, piecewise linear law for each voltage.

OBSERVATION OF ARCING INSIDE A FUSE UNDER CAPACITOR DISCHARGE USING 5-MILLION FRAMES PER SECOND X-RAY IMAGING

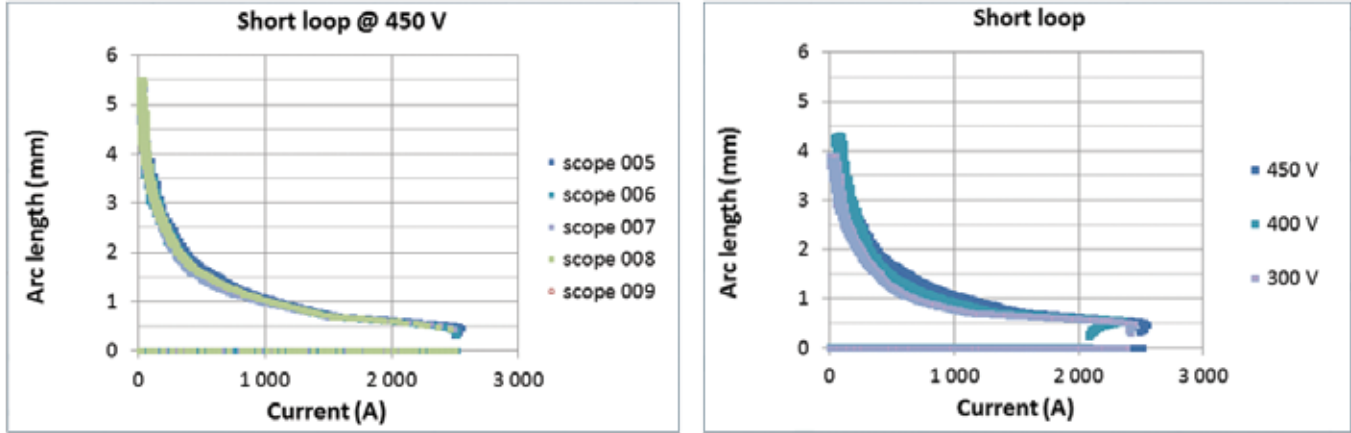

Figure 11: Arc lengthening vs. current. Left: repeatability of tests under 450 V. Right: effect of the capacitor voltage.

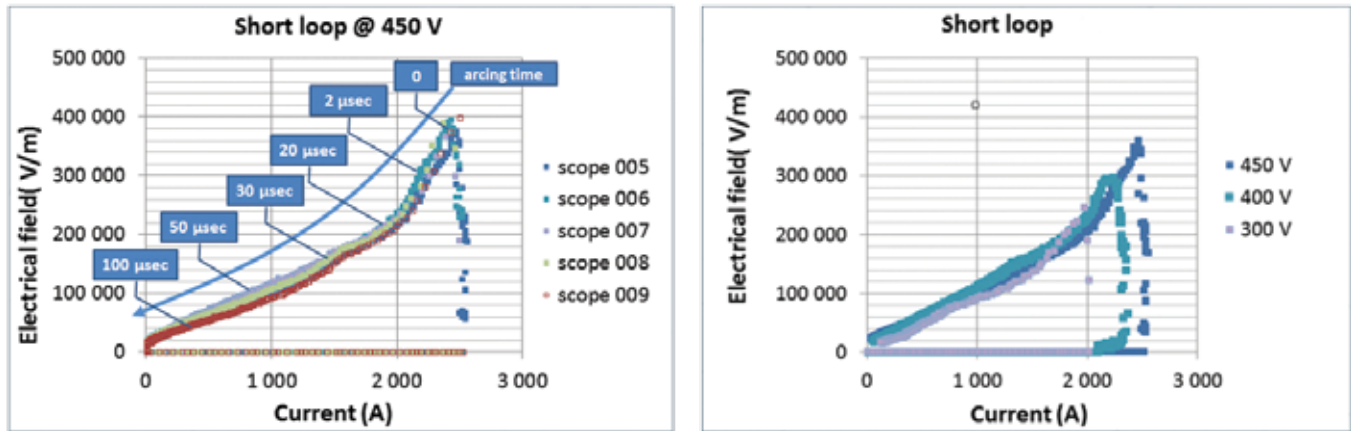

Figure 12: Electrical field. Left: repeatability of tests under 450 V. Right: effect of the capacitor voltage.

5. DISCUSSION

Gnanalingam -Wilkins and Daalder - Schreurs [11] started from the following equation to model the arc:

$$u_a = u_b + \int_0^x E \cdot dx$$

Where:

- u_a arc voltage
- u_b voltage at the electrodes (anodic and cathodic)
- E electric field (V/mm)
- x length of the arc

Table III: Models of the literature for the voltage at the electrodes, the electric field and the rate of lengthening during fuse operation.		
Voltage at the electrodes	Electric field	Length
Dolegowski: $U_{electrodes} = (20 \pm 5) + 1.5 \cdot [i(t)]^{0.39}$	Wheeler [12]: $E = \frac{[K \cdot i(t)]^{0.4}}{S^{\gamma}}$	Gnanalingam and Wilkins: $dx/dt = (a + b \cdot i^{0.6}) \cdot i/S$ S: section for conduction (mm ²)
Gnanalingam and Wilkins: $U_{electrodes} = 15 + 1.0 \cdot [i(t)]^{0.39}$	cylindrical geometry: $K \approx 1.93$ to 2.55 $\gamma = 0.7$ plane geometry: $K \approx 3.5$ to 4.6 $\gamma = 0.85$	

OBSERVATION OF ARCING INSIDE A FUSE UNDER CAPACITOR DISCHARGE USING 5-MILLION FRAMES PER SECOND X-RAY IMAGING

Based on these bibliographic data, we focused our study on the curve of electrical field vs. current.

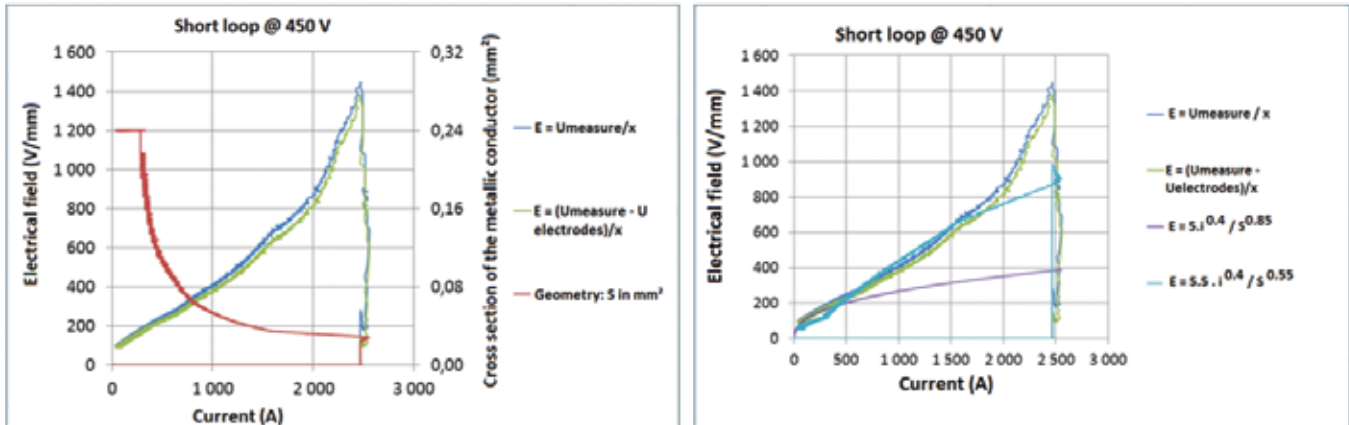

Figure 13: Curves of measured electrical field vs. current. Left: the value of the element cross-section has also been plotted. Right: Curves calculated from Wheeler have also been plotted.

The electrical field is calculated from the measurements of the voltage and the arc length, by either taking into account the electrode drop voltage or not. But the results for both methods are very close as shown in figure 13. The same figure presents several areas. From right to left:

- On the very right, a very sharp increase of the electrical field, corresponding to the establishment of the arc voltage and to the “explosion” of the metallic conductor.
- Between 2500 and 1650 A, a fast drop-down of the value of the field, the shape of the curve $E = f(i)$ being far from the literature. An explanation could be that the arc is not yet at the thermo-dynamic equilibrium. It is noticeable that the current then reaches 1650 A and the time is 10 μsec . This duration should correspond to the time-constant of de-ionization (or ionization) of the arc.
- Between 1650 and 620 A, the curve of the field vs. the current can be fitted by a law $E(i) = (5.1^{0.4})/S^{0.55}$ which, according to Wheeler, is between laws for cylindrical and flat conductors.
- Under 620 A, the curve of the field vs. the current can be fitted by a law $E(i) = (5.1^{0.4})/S^{0.85}$ close to the one proposed by Wheeler for a flat conductor.

6. CONCLUSION

Researchers from Mersen Saint-Bonnet-de-Mure, Grenoble INP, Ecole des Mines de Saint-Etienne, in collaboration with scientists from European Synchrotron Radiation Facilities located at Grenoble, used the sophisticated single-bunch imaging techniques available at ESRF to track the ultrafast processes that take place in fuses during electrical breakdown. Numerous X-ray movies synchronized with current and voltage during operations, for several combinations of electrical parameters and geometrical parameters of the fuse constitute a precious database.

Tests sessions brought a new and better knowledge of arcing in a fuse. First very valuable information concerns the determination of the initial conditions for any arc model. Very spectacular pictures of the transition between prearcing and arcing have been got which will help to make the decision about the initial dimensions of the arc. They also allow to observe the “explosion” of the metallic conductor and to validate or not different hypothesis of the literature i.e. internal nucleation, magneto-hydrodynamics or surface vaporization. Second valuable information comes from the comparison of the curve of the electrical field vs. the current with models available in the literature and concerns a possible preliminary phase of arcing during which the plasma is out of thermodynamic equilibrium. It has not been yet demonstrated that this phase is specific to high di/dt -arcing, but it is probably necessary to take it into account in the design of the fuses.

OBSERVATION OF ARCING INSIDE A FUSE UNDER CAPACITOR DISCHARGE USING 5-MILLION FRAMES PER SECOND X-RAY IMAGING

7. BIBLIOGRAPHY

- [1] J.L. Gelet, "To the origins of fuses," International Conference on Electrical Fuses and their Applications, Clermont-Ferrand, 2007.
- [2] A.D. Stokes, D.K. Sweeting, "Electric arcing burn hazards," International Conference on Electrical Fuses and their Applications, Gdansk, 2003.
- [3] W. Bussière, "Influence of sand granulometry on electrical characteristics, temperature and electron density during high-voltage fuse arc extinction," Journal of Physics D: Appl. Phys. 34 925-935, 2001.
- [4] A. Rack, M. Scheel, L. Hardy, C. Curfs, A. Bonnin and H. Reichert, "Exploiting coherence for real-time studies by single-bunch imaging," Journal of Synchrotron Radiation 21, 815-818, 2014.
- [5] A. Coulbois, "Etude de la transition préarc-arc dans les éléments fusibles," Thèse de doctorat en Physique des plasmas. Université de Clermont-Ferrand, France, 2015.
- [6] H.W. Turner, C. Turner, "Calculation of burn-back rate of a fuse-element and its relation to contact erosion," Switching Arc Phenomena," Łódź 1977.
- [7] M. Dolegowski, "Calculation of the course of the current and voltage of a current limiting fuse," ICEFA Liverpool, 1978.
- [8] Y.J. Onuphrienko, "On researches of the arcing process in fuses with filler (sand filled fuses)," 3rd Int. Symp. on switching arc phenomena, Lodz, Poland, 1977.
- [9] A. Wright, K.J. Beaumont, "Analysis of high-breaking capacity fuselink arcing phenomena," Proc. IEE, 123, pp 252-258, 1976.
- [10] S. Gnanalingam, R. Wilkins, "Digital simulation of fuse breaking tests," IEE PROC. Vol. 127. Pt; C, No.6, 1980.
- [11] J.E. Daalder, E.F. Schreurs, "Arcing phenomena in high voltage fuses," Department of Electrical Engineering, Eindhoven University of Technology, EUT report 83-E-137, 1983.
- [12] C.B. Wheeler, "The high-power constricted plasma discharge column - 1." Theoretical analysis, J. Phys. D. 3. pp 1374-1380, 1970.

CONTACTS

JEAN-FRANÇOIS DE PALMA

Mersen France Angers SAS
2, rue de Déry. 49480 Verrières en Anjou. France
jean.francois.depalma@mersen.com

JEAN-LOUIS GELET

Mersen France SB SAS
15, rue Jacques de Vaucanson. 69720
Saint-Bonnet de Mure. France
jean.louis.gelet@mersen.com
TT-PEN7-001 | PDF | 10.17 | ©2017 Mersen

USA

374 Merrimac Street
Newburyport, MA 01950
T 978 462 6662
info.nby@mersen.com

CANADA

6200 Kestrel Road
Mississauga, ON L5T 1Z1
T 905 795 0077
technicalservices.mis@mersen.com