

# Surge protection solutions

Surge-Trap® IEC Type 1, 1+2, 2, 2+3  
Lightning and surge protection

NEW  
LINE



# Risk of electrical surges

## Lightning and surge protection

Electrical and electronic equipment is indispensable in the daily activities of today's businesses and individuals. Such devices are connected to the electricity grid, often exchanging data and signals through communication lines and are usually sensitive to disturbances. These interconnecting **networks provide a propagation path for overvoltages.**

**Protection against lightning and overvoltages** not only ensures the **safety of people, goods and equipment**, but also ensures **continuity of installation services** and meet criteria of **energy efficiency.**

Overvoltage protection **extends the life of the equipment by more than 20%**, which significantly **reduces the volume of electronic waste.** It also reduces the power consumption of the installations, all of which **translates into cost savings** and environmental sustainability.

5.000.000  
Lightning strikes per day

61%  
electrical damages caused by surges

30kA  
Average current of a lightning strike

## Transient voltage surges in LV power lines

Transient overvoltages are voltage surges that can **reach tens of kilovolts** with a duration of the order of **microseconds.**

Despite their short duration, the high energy content can cause serious problems to equipment connected to the line, from **premature aging to destruction, causing disruptions to service and financial loss**

This type of surge can have various different causes, including **atmospheric lightning** directly striking the external protection (lightning rods) on a building or transmission line or the associated **induction of electromagnetic fields on metallic conductors.** Outdoor and longer lines are the most exposed to these fields, which often receive high levels of induction.

It is also common for **non-weather phenomena**, such as **transformer centre switching** or the **disconnection of motors or other inductive loads** to cause voltage spikes in adjacent lines.

The protector will **discharge excess energy to earth**, thus limiting the peak voltage to a value acceptable for the electrical equipment connected.

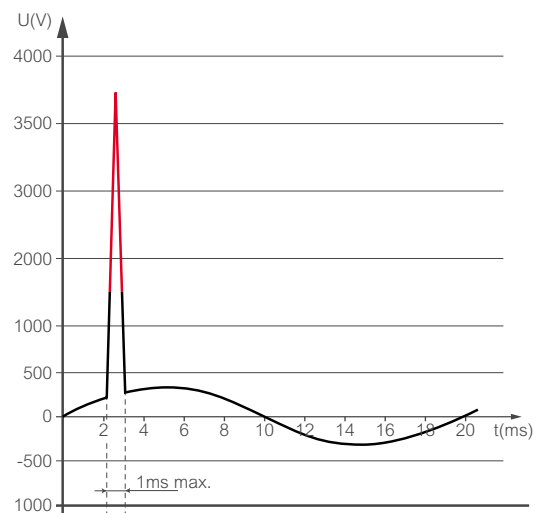

When the peak voltage reaches a value higher than the equipment can withstand, it causes its destruction.

## The importance of the ground connection

**A ground in proper conditions is therefore an aspect not to overlook when it comes to effective surge protection. Continuously monitoring the state of the ground connection** ensures proper operation of surge protection devices. See page 27.

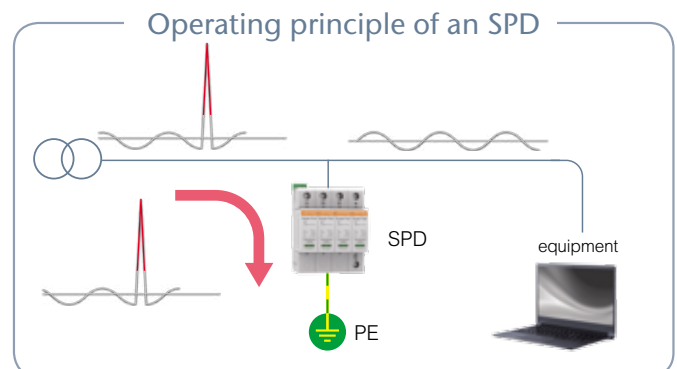

# Why Mersen?

## Expertise in power quality

### Your global electrical power partner

Mersen is a leading market player with innovative solutions in the field of lightning and surge protection.

We design, manufacture, test and certify our products and your systems.

### Safety & reliability for surge protection

- **Bringing together the experience** of the principal international **manufacturing and test standards** for SPDs (IEC and UL)
- **Unique expertise in the combination of SPD and fuse technology**, one of the hot topics in the SPD industry
- **Innovative ranges combining surge protection and ground monitoring** to provide full safety and continuity of service
- **World-class surge test platform**, with laboratories holding accreditations for both IEC/EN 61643 (Terrassa) and UL 1449 3rd ed (Newburyport)
- **Global manufacturing footprint** of a comprehensive range of solutions covering both IEC and UL markets
- **Leadership in POP (TOV)** (Power-frequency Overvoltage Protection) and combined **SPD+POP** devices. EN 50550.
- Wide range of solutions targeting **industrial, commercial and residential applications**

### World-class surge test platform

Mersen is committed to **innovation**. The proof of that quest for continual improvement: a total of more than a million tests in 25 years!

In the field of lightning and surge protection Mersen has a highly specialized team, test laboratories, high investment in R&D&i, international patents and presence on standards committees.

Mersen has two surge test labs: one in Newburyport, Massachusetts, and one state of the art Lightning and Surge protection test lab in Terrassa, Spain, namely the Global Center of Excellence for IEC Surge Protection. The two are complementary, in terms of the available resources, to be able to offer the **widest possible range of tests to IEC, UL and NFC standards**.

## Lightning and surge protection

Mersen offers a wide range of solutions along with advice and consulting services as well as after sale service



**SPD – Surge-Trap®**  
Surge protective devices to IEC and NEMA/UL. Also for telecom and signalling networks. [See page 12-25](#)



**GND** – Grounding system monitors. [See page 27](#)



**REC** – Smart automatic reclosers. Fully programmable. POP (TOV) + RCD + MCB [See page 26](#)



**POP (TOV)** - Power-frequency Overvoltage Protection. EN 50550. (Temporary Overvoltages TOV) [See page 26](#)



**ESE** – Electronic Early Streamer Emission lightning air terminals.



**IMD** – Insulation Monitoring Devices. Electric vehicle, photovoltaic and IT power supplies.

Mersen welcomes customers at both locations to run test campaigns focused on critical points in their own bills of requirements



# Implementing the protection to IEC 61643

## Protection parameters according to IEC 61643

### Iimp

#### Impulse current

Peak current with **10/350µs** waveform which the protection device can withstand without reaching end of life.

### I<sub>max</sub>

#### Maximum discharge current

Peak current with **8/20µs** waveform which the protection device can withstand without reaching end of life.

### I<sub>n</sub>

#### Nominal current

Peak current in **8/20µs** waveform the protection device can withstand 20 times without reaching end of life.

### U<sub>p</sub>

#### Voltage protection level

**Maximum residual voltage** between the terminals of the protection device during the application of a peak current equal to the nominal current (I<sub>n</sub>).

### U<sub>c</sub>

#### Maximum continuous operating voltage

Maximum effective voltage that can be applied permanently to the terminals of the protection device.

### U<sub>oc</sub>

#### Open circuit voltage (combined voltage pulse)

This parameter is used only for the Class III test and is applicable to a Type 3 SPD. It consists of the injection of a combination wave (**1.2/50µs** in open circuit - **8/20µs** in short circuit).

### I<sub>fi</sub>

#### Follow current extinction capability

This parameter is only devoted to surge protectors using "air gap" technology. Once they have "switched", these surge protectors conduct part of the network current (follow current) and need to interrupt it.

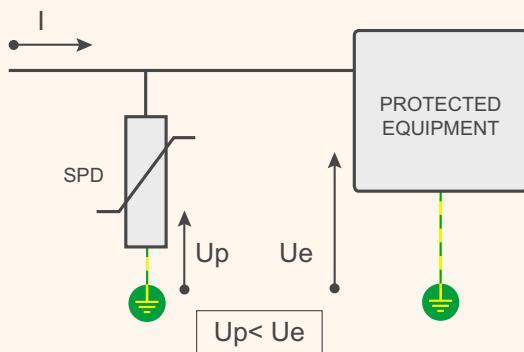

I: peak current

U<sub>p</sub>: voltage protection level. Residual voltage at I<sub>n</sub>.

U<sub>e</sub>: impulse voltage the equipment can withstand

When selecting an SPD, several points must be considered:

- **Network topology:** TNS, TNC, TT, IT, PV and No of conductors.
- **Nominal voltage rating (U<sub>n</sub>)** of the supply.

Both features will condition the **maximum continuous operating voltage (U<sub>c</sub>)** as the IEC standard 60364-5-534 sets the minimum allowed value of U<sub>c</sub> depending on the system configuration, taking into account a safety margin of the device above the nominal voltage.

- **Voltage withstand rating (U<sub>e</sub>)** of the equipment in the installation. The protection device should be selected so that the **voltage protection level (U<sub>p</sub>)** is compatible with (lower than) the value of U<sub>e</sub>. IEC standard 60364-4-443 classifies equipment into four categories, based on the impulse voltage they are capable of withstanding. (See page 5, figure)
- **Exposure of the installation** to atmospheric and non-weather phenomena.

## Exposure ratings

The actual exposure of an installation depends on the combination of 3 basic criteria: (1) **electrical service system**, (2) **external (and internal) switching** of loads and (3) **lightning strike density** (isokeraunic level).

- Factors (1) and (2) generate three possible situations:



- **Direct impact** exposure of an installation fitted with external lightning protection system or close to a tower or element susceptible to receive a strike.



- **High** exposure of an installation fed by long overhead service lines or situated in large industrial or commercial premises.



- **Medium** exposure of installations with an underground service and not subject to switchings of industrial loads in the vicinity.

- Factor (3), the **isokeraunic level** of a certain country.

See page 8 for a basic recommendation guide.

## Isokeraunic map

Density of lightning strikes on the ground N<sub>g</sub> (strikes/year · km<sup>2</sup>)



180

Level of risk

4

+

-

## Protection system of coordinated stages: Type 1, 2 and 3 SPDs

The SPDs of a surge protection system must be able to withstand the discharged current and provide a  $U_{res}$  level (residual voltage) lower than the  $U_e$  peak voltage that the equipment can withstand.

Most of the times it is not possible to achieve this with just one SPD, especially because the intensity of the surge is not known, and because of the induction of overvoltages when

conductors exceed 10m. The optimal system of protection is the **3-STEP approach, in which successive stages are combined in the performance of high discharge capacity devices and devices with an optimal voltage protection level (low)**. This is addressed by the definition of “Types” or “Classes” of SPDs according to the type of transient pulses to which each protected zone in the installation is subject to.

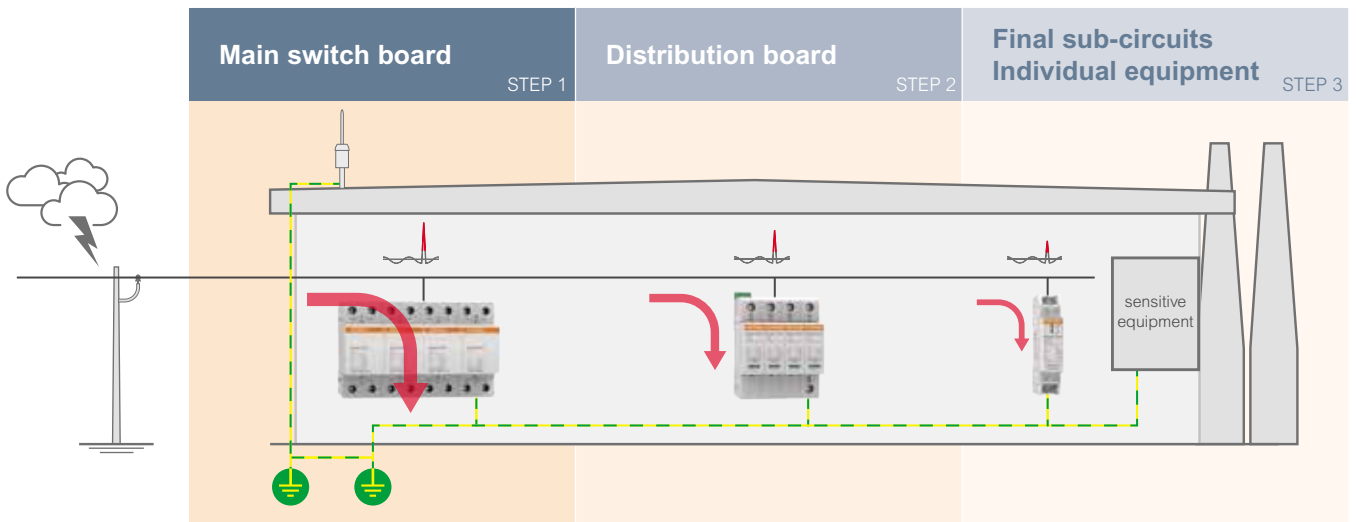

Overvoltage category IEC 60364-4-443	IV	III	II	I
Overvoltage withstand ( $U_e$ ) values for equipment at 230/400V	6kV	4kV	2,5kV	1,5kV

IEC/EN 61643	Type 1 / Class I	Type 2 / Class II	Type 3 / Class III
Definition	Designed for use in incoming power supply panels where the risk of lightning strike is high, in particular in buildings with an external lightning protection system. Must be accompanied by downstream Class II protectors.	Designed for use in distribution panels located downstream of class I protectors or in incoming power supply panels in areas with low exposure to lightning strikes, where the building is not fitted with an external LPS.	Always installed downstream of a Class II protection designed to protect sensitive equipment or equipment located more than 20m downstream of the Class II SPD.
LPZ IEC 62305-4 protection zone	LPZ 1	LPZ 2	LPZ 3
Class test to IEC/EN 61643	10/350 $\mu$ s waveform, Class I test.	8/20 $\mu$ s waveform, Class II test.	Combined 1.2/50 $\mu$ s-8/20 $\mu$ s waveform Class III test.
Surge	Direct impact of a lightning strike (current).	Indirect impact of a lightning strike on the distribution line (overhead lines) or its vicinity (rise of ground potential or induction by coupling of electromagnetic radiation of the strike) or in the event of a switching.	Indirect impact simulated by the current and voltage that can reach the long-distance circuits and individual equipment to be protected.
Discharge capacity ( $I_{imp}$ , $I_{max}$ )	High	Medium	Low
Voltage protection level ( $U_p$ )	√ (Coarse)	√√ (Fine)	√√√ (Very fine)
Mersen Surge-Trap® series	STM T1	STP T12	STP T23; STM T23 S; STL T23; STE T23
		STP T2; STP T2 PV	

# Surge-Trap® range overview

NEW  
LINE



FIRST  
STEP OF  
PROTECTION  
50kA

## STM T1

See page 12



COMBINED  
TYPE 1+2

## STP T12

See page 13



WIDE  
RANGE

## STP T2

See page 16



PV  
EN50539-11  
UL 1449

## STP T2 PV

See page 19

<b>Location</b>	First step of protection		First step of protection	Second step of protection	For DC photovoltaic applications
<b>SPD Type</b>	Type 1 lightning current arrester to IEC/EN 61643		Type 1+2 SPD to IEC/EN 61643	Type 2 SPD to IEC/EN 61643	Type 2 DC to EN-50539-11 UTE C 61740-51 UL 1449 3rd Ed. recognised
<b>Iimp (10/350µs)</b>	50kA (phase) / 100kA (N-PE)		12.5kA		
<b>I<sub>max</sub> (8/20µs)</b>			50kA	40kA	40kA
<b>I<sub>n</sub> (8/20µs)</b>	50kA (phase) / 100kA (N-PE)		20kA	20kA	20kA
<b>Uoc (1.2/50µs)</b>					
<b>Special features</b>	I <sub>fi</sub> = 50kA follow current interrupt rating. Multi-sparkgap technology. Leakage current free.		ELV: Extra Low Voltage models available. Reversible & coded cartridges.	ELV: Extra Low Voltage models available. Reversible & coded cartridges.	I <sub>scpv</sub> = 10kA (no back-up fuse needed). SCCR 100kA and 50kA. Reversible & coded cartridges.
<b>Supply voltage U<sub>n</sub> (L-N/L-L)</b>	120/208V, 230/400V, 277/480V		60V 120/208V, 230/400V, 277/480V 400/690V	48V, 60V 120/208V, 230/400V, 277/480V 400/690V + above	65Vdc, 80Vdc 660Vdc, 1060Vdc 1200Vdc, 1500Vdc
<b>Network configuration</b>	TNS, TNC, TT	Single phase Split phase 3-phase WYE; Delta	TNS, TNC, TT, IT	Single phase Split phase 3-phase WYE; Delta	PV (DC side)
<b>Format</b>	DIN-rail mountable. Monobloc format		DIN-rail mountable. Pluggable format		DIN-rail mountable. Pluggable format
<b>Type according to EN 61643-11</b>	<b>TYPE 1</b>		<b>TYPE 1+2</b>		<b>TYPE 2</b>



# One solution for every step of protection



**FINE PROTECTION**

## STP T23

See page 20



**SLIM: SPACE SAVING**

## STM T23 SLIM

See page 23



**POWERFUL EMI FILTER**

## STE T23 EMI

See page 24



**LED STREET-LIGHT 10kV**

## STL T23 LED

See page 25

Final stage of protection (very fine)	Final stage of protection (very fine)	Final stage of protection (very fine)	For installation in the pole or OEM in the luminary of outdoor LED lighting systems
Type 2+3 SPD to IEC/EN 61643	Type 2+3 SPD to IEC/EN 61643	Type 2+3 SPD to IEC/EN 61643	Type 2+3 SPD to IEC/EN 61643, with CB scheme. Luminary "surge tested" and certified (optional)
20kA	20kA / 6kA	20kA	10kA
10kA	10kA / 3kA	10kA	5kA
10kV	10kV / 6kV	6kV	10kV
PLC: Power Line Communication friendly solutions (LCF). Reversible & coded cartridge.	Ideal for limited spaces (1 module).	Filter attenuation up to 82dB (common mode) vs electromagnetic disturbances. Rated current load up to 20A.	Class 1 and Class 2 luminaires. Miniature size and easy to install.
120/208V, 230/400V, 277/480V 400/690V	12V, 24V, 48V, 60V 120V, 230V Also for use in DC voltage applications	120V, 230V	230V (Contact us for other voltages)
TNS, TNC, IT, TT Single phase Split phase 3-phase WYE; Delta	Single Phase TT, TNS	Single Phase TT, TNS	Solutions for all types of electrical grids (configurations and voltages)
DIN-rail mountable. Pluggable format	DIN-rail mountable. Monobloc format	DIN-rail mountable. Monobloc format	Hardwired

TYPE 2+3

**kA**  
Discharge capacity

### Approvals / Standards



# Basic guide to selection of SPDs

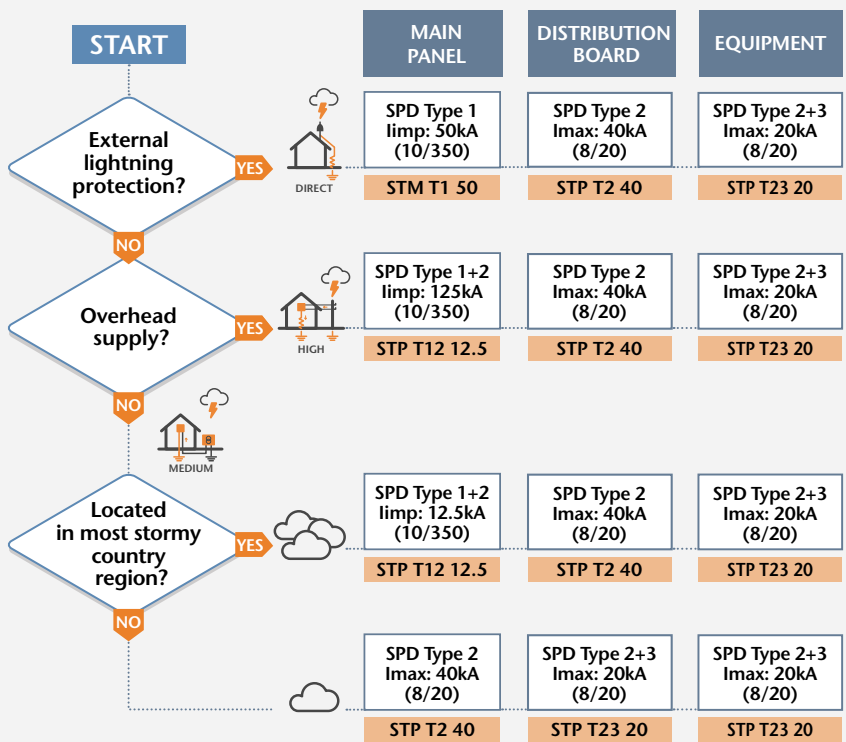

INDUSTRIAL OR LARGE APPLICATIONS



SMALL COMMERCIAL OR RESIDENTIAL

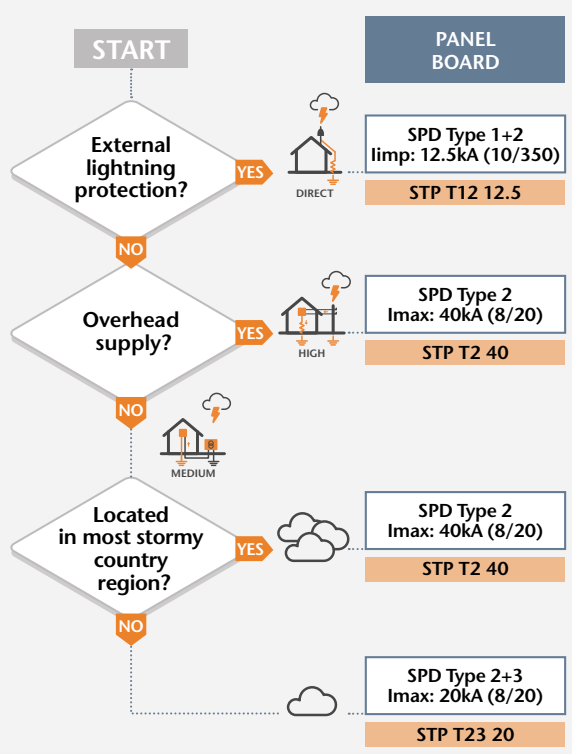



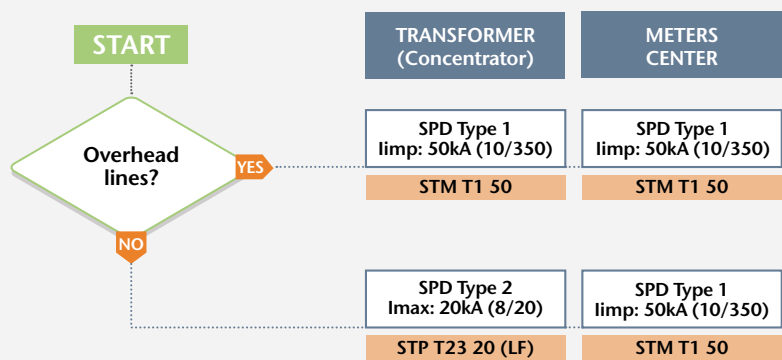
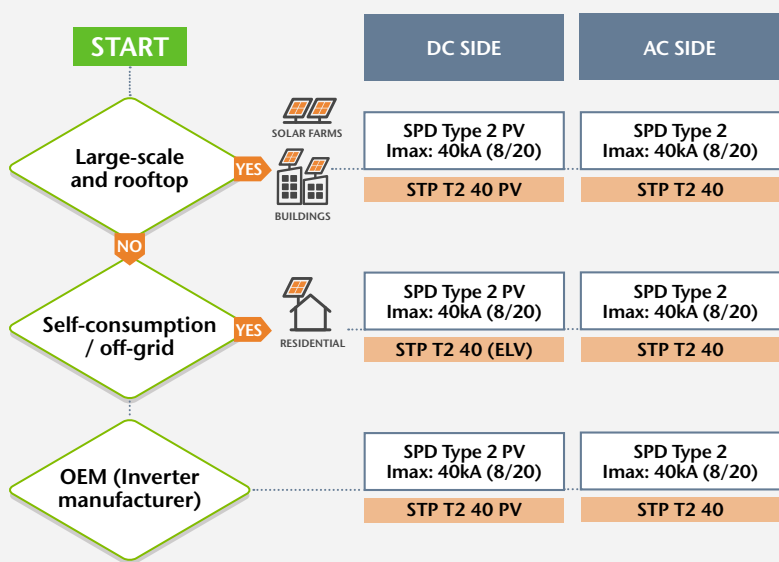
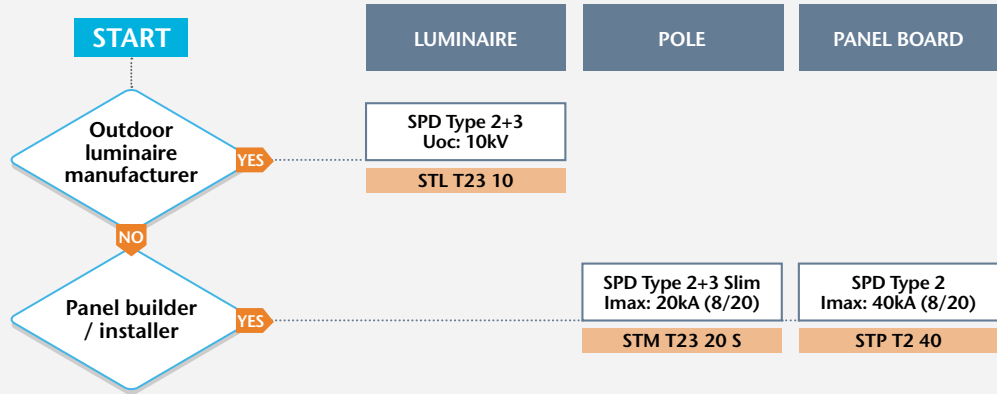

MERSEN SOLUTION **SPD LOCATION**

# Surge-Trap® highlights

## STP Surge-Trap® Pluggable

See page 13-21

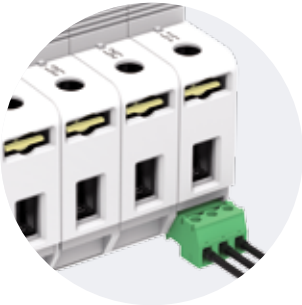

### Remote indication

Dry contacts, optional in all ranges, for remote indication of protector end of life.



### Biconnect connection

Two types of terminal: for rigid or flexible cable and for fork type comb busbar.



### Mersen quality

Product range produced entirely by Mersen, with a thermal disconnection system. Use of the best materials and components.

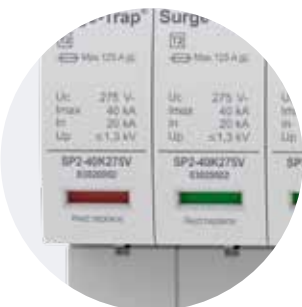

### Protector lifetime status indication

Clear display of protection end of life.



### Cartridge security system

Vibration proof insertion "click" effect.

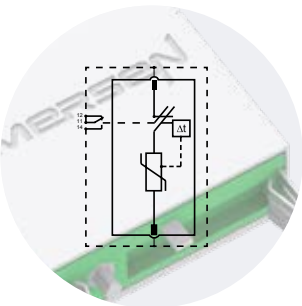

### New, optimised disconnection system

Mersen has developed an optimised disconnection system for end of life. Complies with the disconnection tests of the standards for protectors for photovoltaic applications.

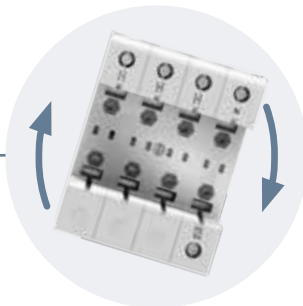

### Reversible installation

Reversible chassis to allow cable entry from above or below.



### Mechanical cartridge coding

Safety system to avoid possible cartridge replacement errors.

# The best performance in the market

## STM T1

See page 12

### Type 1 lightning current arrester

- Discharges impulse currents with a 10/350µs waveform: 50kA per phase.
- Leakage current free (LCF).



### Multi Spark Gap

- Follow current quenching capacity. I<sub>fi</sub>: 50kA.
- Low residual voltage.



## STM T23 SLIM

See page 23

### Status indication

Remote and visual indication of life status of the protection device.



### Type 2+3, 2 poles in 1 module

Compact combined device (Type 2+3) for fine protection. Ideal for limited spaces.

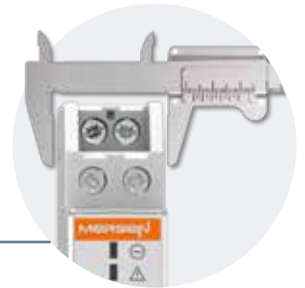

## STE T23 EMI

See page 24

### EMI / RFI Filter

All models include an electromagnetic filter for network noise.

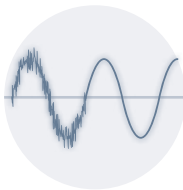

### Combined SPD (Type 2+3)

Combined devices for discharging induced transient overvoltages, while providing a very fine protection level for sensitive equipment.

## STL T23 LED

See page 25

### Solutions for LED lighting luminaires

The range of surge protectors for LED luminaires is suitable for all network configurations and all voltages (including IT systems). Mersen has solutions for class I and class II luminaires.



### Compact and easy to install in any luminaire

Mersen has designed a compact solution which fits any luminaire (OEM Solutions).

10kV protection

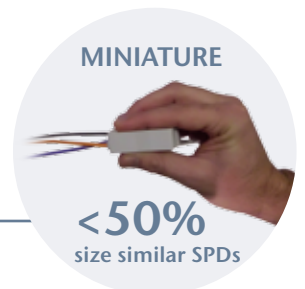

MINIATURE

< 50%  
size similar SPDs

# Surge-Trap® Type 1 SPDs

Imp   
**50 kA**



[ep.mersen.com](http://ep.mersen.com)



## STM T1 50

**STM T1 50** is the most robust series of single pole Type 1/ Class I lightning current arresters, able to discharge energy (current) from a direct lightning strike (10/350µs) on an external lightning protection system (LPS) or overhead supplies, in accordance with EN/IEC 61643. Suitable as the first step of protection in incoming power supply panels and areas with high exposure to lightning strikes, fitted with an external lightning protection system.

### Ratings and features

- Lightning impulse current (10/350µs): 50kA
- Follow current quenching capacity (Ifi): 50kA
- Leakage current free (LCF)
- Multi-discharge technology
- Single pole devices for TNS, TNC and TT earthing systems
- Un(L-N/L-L): 120/208V, 230/400V, 277/480V
- DIN-rail mountable, monobloc format

### Approvals/Standards

- IEC/EN 61643
- CE



GUIDE

Example

## STM T1 - 50K 275V - 1P

**Surge-Trap® Monobloc Type 1 / Class I** lightning current arrester (10/350µs)

### Step 1

Lightning impulse current

- 50K** Iimp (L-N) = 50kA
- 100K** Iimp (N-PE) = 100kA

### Step 2

Operating voltage

Uc	Un (L-N/L-L)
<b>150V</b>	120/208V
<b>275V</b>	230/400V
<b>320V</b>	277/480V
<b>Blank</b>	N-PE protection

### Step 3

Network configuration

- 1P** L-N; 1Ph (TNS, TNC, TT)
- N** N-PE; Neutral (TT Spark-Gap)

### Catalog numbers / Reference numbers

#### 1 pole

Reference number	Catalog number	Network		Un [Vac]	Uc [V]	Iimp(10/350) [kA]	In(8/20) [kA]	Up@In(8/20) [kV]
		System type	Electrical diagram					
83010103	STMT1-50K150V-1P	L-N (1Ph)	A	120	150	50	50	≤2
83010100	STMT1-50K275V-1P	L-N (1Ph)	A	230	275	50	50	≤2
83010104	STMT1-50K320V-1P	L-N (1Ph)	A	277	320	50	50	≤2
83010102	STMT1-100K-N	N-PE (N)	B	Neutral	255	100	100	≤2

### Dimensions

#### 1 pole

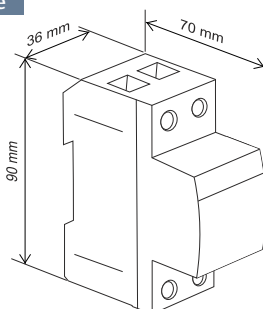

### Electrical diagrams

#### A (1P)

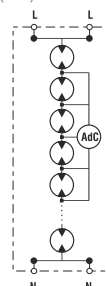

#### B (N)

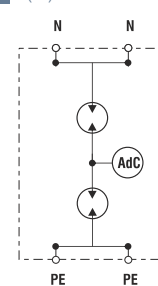

# Surge-Trap® Type 1+2 SPDs

Imp  **12.5 kA**

## STP T12 12.5

**STP T12 12.5** is the series of combined Type 1+2/Class I+II devices for discharging lightning currents and protecting against voltage surges, in accordance with EN/IEC 61643. Suitable as the first step of protection in incoming power supply panels and areas with exposure to the atmosphere, where installations are usually provided with an external lightning protection system.

### Ratings and features

- Lightning impulse current (10/350µs): 12.5kA per phase
- Maximum discharge current (8/20µs): 50kA per phase
- Nominal discharge current (8/20µs): 20kA per phase
- TNS, TNC, TT and IT networks
- Un(L-N/L-L): 60V, 120/208V, 230/400V, 277/480V and 400/690V
- DIN-rail mountable, plug-in format
- Visual and remote end of life indicators
- Reversible chassis to allow cable entry from above or below
- Mechanically coded cartridges to avoid cartridge replacement errors



[ep.mersen.com](http://ep.mersen.com)

### Approvals/Standards

- IEC/EN 61643
- CE



GUIDE

Example

## STP T12 - 12K 275V - 4PG M

**Surge-Trap® Pluggable Type 1+2 / Class I+II** combined lightning current arrester (10/350µs) and surge protective device (8/20µs)

### Step 1

Lightning impulse current  
**12K** Iimp (L-N) =12.5kA  
**25K** Iimp (N-PE) =25kA  
**50K** Iimp (N-PE) =50kA

### Step 2

Operating voltage  
**Uc Un (L-N/L-L)**  
**75V** 60-V  
**150V** 120/208V  
**275V** 230/400V  
**320V** 277/480V  
**440V** 230/400V "IT"  
 400/690V  
**Blank** N-PE protection

### Step 3

Network configuration  
**1P** L-N; 1Ph (TNS, TNC, IT, TT)  
**N** N-PE; Neutral (TT Spark-Gap)  
**2P** 2+0; 1Ph+N (TNS,IT)  
**2PG** 1+1; 1Ph+N (TT)  
**3P** 3+0; 3Ph (TNC,IT)  
**4P** 4+0; 3Ph+N (TNS,IT)  
**4PG** 3+1; 3Ph+N (TT)

### Step 4

Remote monitoring  
**M** Microswitch included

### Dimensions

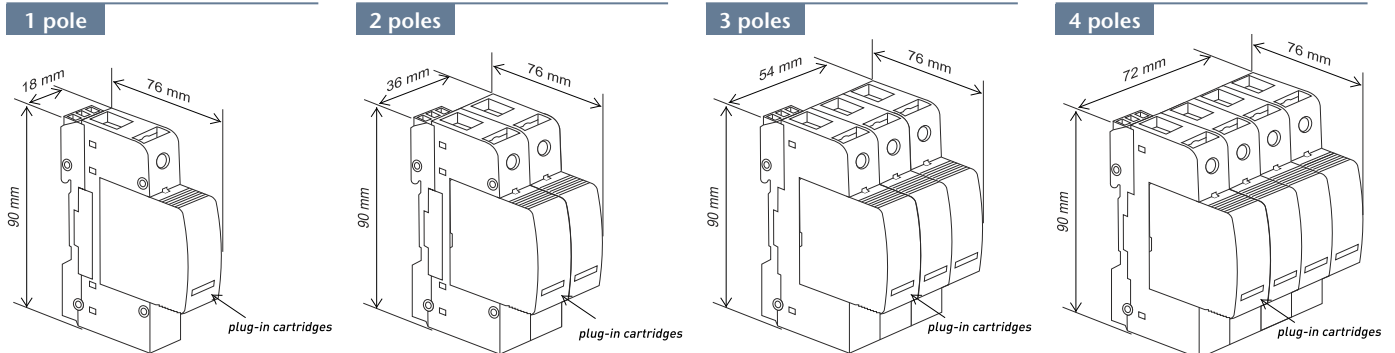

### Microswitch diagram

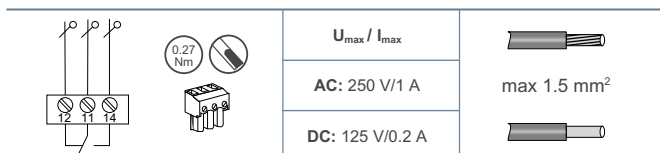

# Surge-Trap® Type 1+2 SPDs | STP T12 12.5

## Catalog numbers / Reference numbers

### 1 pole

Reference number	Catalog number	Network									Cartridge Id.	
		System type	Electrical diagram	Un [Vac]	Uc [V]	Iimp(10/350) [kA]	I <sub>max</sub> (8/20) [kA]	In(8/20) [kA]	Up@In(8/20) [kV]	Remote (M)	L	N
83120100	STPT12-12K150V-1P	L-N (1Ph)	A	120	150	12.5	50	20	≤1		C02	-
83120101	STPT12-12K150V-1PM	L-N (1Ph)	A	120	150	12.5	50	20	≤1	√	C02	-
83120102	STPT12-12K275V-1P	L-N (1Ph)	A	230	275	12.5	50	20	≤1.3		C03	-
83120103	STPT12-12K275V-1PM	L-N (1Ph)	A	230	275	12.5	50	20	≤1.3	√	C03	-
83120104	STPT12-12K320V-1P	L-N (1Ph)	A	277	320	12.5	50	20	≤1.4		C04	-
83120105	STPT12-12K320V-1PM	L-N (1Ph)	A	277	320	12.5	50	20	≤1.4	√	C04	-
83120106	STPT12-12K440V-1P	L-N (1Ph)	A	400	440	12.5	50	20	≤1.8		C05	-
83120107	STPT12-12K440V-1PM	L-N (1Ph)	A	400	440	12.5	50	20	≤1.8	√	C05	-
83120108	STPT12-25K-N	N-PE (N)	B	Neutral	255	25	50	25	≤1.5		-	C06
83120110	STPT12-50K-N	N-PE (N)	B	Neutral	255	50	50	50	≤1.5		-	C07

### 2 poles

Reference number	Catalog number	Network									Cartridge Id.	
		System type	Electrical diagram	Un [Vac]	Uc [V]	Iimp(10/350) [kA]	I <sub>max</sub> (8/20) [kA]	In(8/20) [kA]	Up@In(8/20) [kV]	Remote (M)	L	N
83120126	STPT12-12K75V-2P	TNS (1Ph+N); PV	C	60/-	75; 80 Ucpv	12.5	50	20	≤0.65		C01	
83120127	STPT12-12K75V-2PM	TNS (1Ph+N); PV	C	60/-	75; 80 Ucpv	12.5	50	20	≤0.65	√	C01	
83120112	STPT12-12K150V-2PG	TT (1Ph+N)	D	120/-	150	12.5 (L-N) 25 (N-PE)	50	20	≤1 (L-N) ≤1.5 (N-PE)		C02	C06
83120113	STPT12-12K150V-2PGM	TT (1Ph+N)	D	120/-	150	12.5 (L-N) 25 (N-PE)	50	20	≤1 (L-N) ≤1.5 (N-PE)	√	C02	C06
83120114	STPT12-12K275V-2PG	TT (1Ph+N)	D	230/-	275	12.5 (L-N) 25 (N-PE)	50	20	≤1.3 (L-N) ≤1.5 (N-PE)		C03	C06
83120115	STPT12-12K275V-2PGM	TT (1Ph+N)	D	230/-	275	12.5 (L-N) 25 (N-PE)	50	20	≤1.3 (L-N) ≤1.5 (N-PE)	√	C03	C06
83120116	STPT12-12K320V-2PG	TT (1Ph+N)	D	277/-	320	12.5 (L-N) 25 (N-PE)	50	20	≤1.4 (L-N) ≤1.5 (N-PE)		C04	C06
83120117	STPT12-12K320V-2PGM	TT (1Ph+N)	D	277/-	320	12.5 (L-N) 25 (N-PE)	50	20	≤1.4 (L-N) ≤1.5 (N-PE)	√	C04	C06
83120118	STPT12-12K150V-2P	TNS (1Ph+N)	F	120/-	150	12.5	50	20	≤1		C02	
83120119	STPT12-12K150V-2PM	TNS (1Ph+N)	F	120/-	150	12.5	50	20	≤1	√	C02	
83120120	STPT12-12K275V-2P	TNS (1Ph+N)	F	230/-	275	12.5	50	20	≤1.3		C03	
83120121	STPT12-12K275V-2PM	TNS (1Ph+N)	F	230/-	275	12.5	50	20	≤1.3	√	C03	
83120122	STPT12-12K320V-2P	TNS (1Ph+N)	F	277/-	320	12.5	50	20	≤1.4		C04	
83120123	STPT12-12K320V-2PM	TNS (1Ph+N)	F	277/-	320	12.5	50	20	≤1.4	√	C04	
83120124	STPT12-12K440V-2P	IT (1Ph+N); TNS(1Ph+N)	C	230/-; 400/-	440	12.5	50	20	≤1.8		C05	
83120125	STPT12-12K440V-2PM	IT (1Ph+N); TNS(1Ph+N)	C	230/-; 400/-	440	12.5	50	20	≤1.8	√	C05	

ELV

ELV Extra Low Voltage, also for use in DC Photovoltaic self-consumption / off-grid applications.

## Electrical diagrams

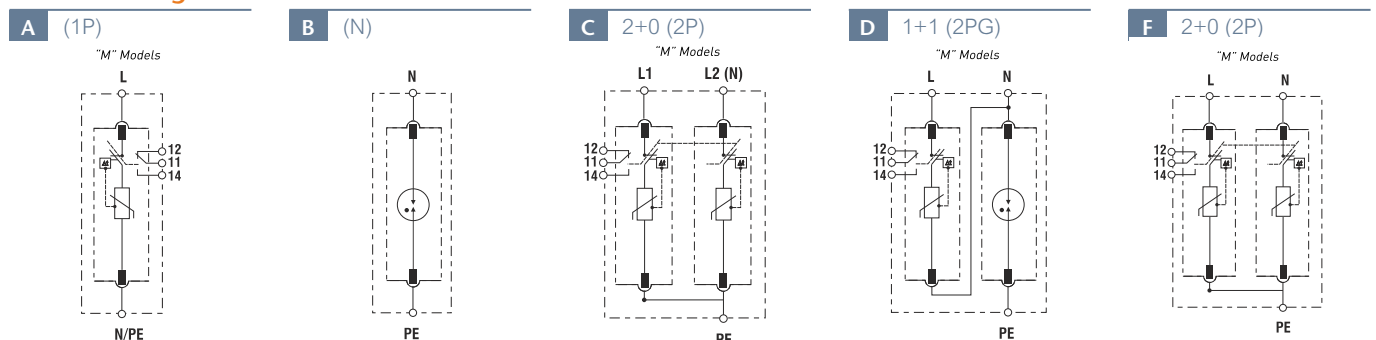

# Surge-Trap® Type 1+2 SPDs | STP T12 12.5

## 3 poles

Reference number	Catalog number	Network		Un [Vac]	Uc [V]	Iimp(10/350) [kA]	Imax(8/20) [kA]	In(8/20) [kA]	Up@In(8/20) [kV]	Remote (M)	Cartridge Id.	
		System type	Electrical diagram								L	N
83120128	STPT12-12K150V-3P	TNC (3Ph)	H	-/208	150	12.5	50	20	≤1		C02	-
83120129	STPT12-12K150V-3PM	TNC (3Ph)	H	-/208	150	12.5	50	20	≤1	√	C02	-
83120130	STPT12-12K275V-3P	TNC (3Ph)	H	-/400	275	12.5	50	20	≤1.3		C03	-
83120131	STPT12-12K275V-3PM	TNC (3Ph)	H	-/400	275	12.5	50	20	≤1.3	√	C03	-
83120132	STPT12-12K320V-3P	TNC (3Ph)	H	-/480	320	12.5	50	20	≤1.4		C04	-
83120133	STPT12-12K320V-3PM	TNC (3Ph)	H	-/480	320	12.5	50	20	≤1.4	√	C04	-
83120134	STPT12-12K440V-3P	IT (3Ph); TNC (3Ph)	I; H	-/400; -/690	440	12.5	50	20	≤1.8		C05	-
83120135	STPT12-12K440V-3PM	IT (3Ph); TNC (3Ph)	I; H	-/400; -/690	440	12.5	50	20	≤1.8	√	C05	-

## 4 poles

Reference number	Catalog number	Network		Un [Vac]	Uc [V]	Iimp(10/350) [kA]	Imax(8/20) [kA]	In(8/20) [kA]	Up@In(8/20) [kV]	Remote (M)	Cartridge Id.	
		System type	Electrical diagram								L	N
83120136	STPT12-12K150V-4PG	TT (3Ph+N)	J	120/208	150	12.5 (L-N) 50 (N-PE)	50	20	≤1 (L-N) ≤1.5 (N-PE)		C02	C07
83120137	STPT12-12K150V-4PGM	TT (3Ph+N)	J	120/208	150	12.5 (L-N) 50 (N-PE)	50	20	≤1 (L-N) ≤1.5 (N-PE)	√	C02	C07
83120138	STPT12-12K275V-4PG	TT (3Ph+N)	J	230/400	275	12.5 (L-N) 50 (N-PE)	50	20	≤1.3 (L-N) ≤1.5 (N-PE)		C03	C07
83120139	STPT12-12K275V-4PGM	TT (3Ph+N)	J	230/400	275	12.5 (L-N) 50 (N-PE)	50	20	≤1.3 (L-N) ≤1.5 (N-PE)	√	C03	C07
83120140	STPT12-12K320V-4PG	TT (3Ph+N)	J	277/480	320	12.5 (L-N) 50 (N-PE)	50	20	≤1.4 (L-N) ≤1.5 (N-PE)		C04	C07
83120141	STPT12-12K320V-4PGM	TT (3Ph+N)	J	277/480	320	12.5 (L-N) 50 (N-PE)	50	20	≤1.4 (L-N) ≤1.5 (N-PE)	√	C04	C07
83120142	STPT12-12K150V-4P	TNS (3Ph+N)	L	120/208	150	12.5	50	20	≤1		C02	
83120143	STPT12-12K150V-4PM	TNS (3Ph+N)	L	120/208	150	12.5	50	20	≤1	√	C02	
83120144	STPT12-12K275V-4P	TNS (3Ph+N)	L	230/400	275	12.5	50	20	≤1.3		C03	
83120145	STPT12-12K275V-4PM	TNS (3Ph+N)	L	230/400	275	12.5	50	20	≤1.3	√	C03	
83120146	STPT12-12K320V-4P	TNS (3Ph+N)	L	277/480	320	12.5	50	20	≤1.4		C04	
83120147	STPT12-12K320V-4PM	TNS (3Ph+N)	L	277/480	320	12.5	50	20	≤1.4	√	C04	
83120148	STPT12-12K440V-4P	IT (3Ph+N); TNS (3Ph+N)	L	230/400; 400/690	440	12.5	50	20	≤1.8		C05	
83120149	STPT12-12K440V-4PM	IT (3Ph+N); TNS (3Ph+N)	L	230/400; 400/690	440	12.5	50	20	≤1.8	√	C05	

## Electrical diagrams

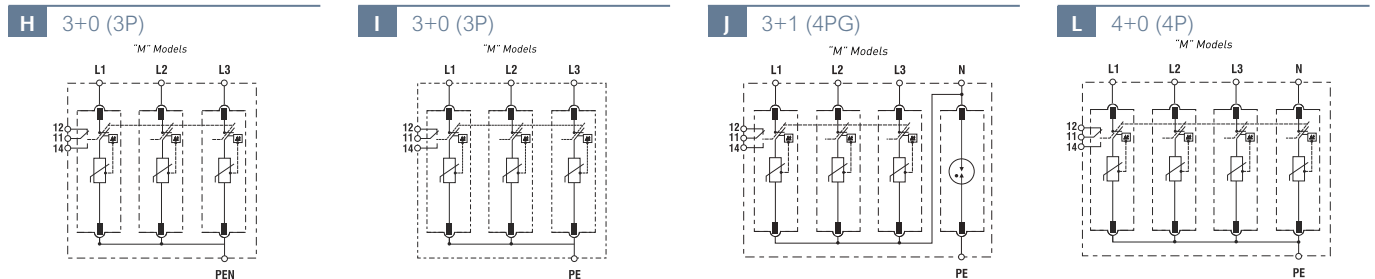

## Replacement cartridges

Reference number	Catalog number	Network	Un [Vac]	Uc [V]	Iimp(10/350) [kA]	Imax(8/20) [kA]	In(8/20) [kA]	Up@In(8/20) [kV]	Cartridge Id.
83120000	SP12-12K75V	L-N (1Ph)	60	75	12.5	50	20	≤0.65	C01
83120001	SP12-12K150V	L-N (1Ph)	120	150	12.5	50	20	≤1	C02
83120002	SP12-12K275V	L-N (1Ph)	230	275	12.5	50	20	≤1.3	C03
83120003	SP12-12K320V	L-N (1Ph)	277	320	12.5	50	20	≤1.4	C04
83120004	SP12-12K440V	L-N (1Ph)	400	440	12.5	50	20	≤1.8	C05
83120005	SP12-25K-N	N-PE (N)	Neutral	255	25	50	25	≤1.5	C06
83120006	SP12-50K-N	N-PE (N)	Neutral	255	50	50	50	≤1.5	C07

# Surge-Trap® Type 2 SPDs

Imax   
**40 kA**



## STP T2 40

**STP T2 40** is the series of Type 2/Class II devices for discharging voltage surges, in accordance with EN/IEC 61643. Suitable for the second stage of protection in supply distribution panels in which Type 1 protection devices are installed upstream, or for the first stage of protection in commercial or other applications not exposed to direct strikes and with no external lightning protection system.

### Ratings and features

- Maximum discharge current (8/20µs): 40kA per phase
- Nominal discharge current (8/20µs): 20kA per phase
- TNS, TNC, TT and IT networks
- $U_n$ (L-N/L-L): 48V, 60V, 120/208V, 230/400V, 277/480V, 400/690V & higher
- DIN-rail mountable, plug-in format
- Visual and remote end of life indicators
- Reversible chassis to allow cable entry from above or below
- Mechanically coded cartridges to avoid cartridge replacement errors



### Approvals/Standards

- IEC/EN 61643
- CE



GUIDE

Example

### STP T2 - 40K 275V - 4PG M

**Surge-Trap®  
Pluggable Type 2 /  
Class II surge  
protective device  
(8/20µs)**

Step 1	Step 2	Step 3	Step 4
Max. discharge current	Operating voltage	Network configuration	Remote monitoring
<b>40K</b> $I_{max}$ (L-N) =40kA <b>30K</b> $I_{max}$ (L-N) =30kA (for 750V only)	<b><math>U_c</math></b> <b><math>U_n</math> (L-N/L-L)</b> <b>60V</b> 48/-V <b>75V</b> 60/-V <b>150V</b> 120/208V <b>275V</b> 230/400V <b>320V</b> 277/480V <b>440V</b> 230/400V "IT"; 400/690V <b>750V</b> 400/690V; 690/1000V <b>Blank</b> N-PE protection	<b>1P</b> L-N; 1Ph (TNS,TNC,IT,TT) <b>N</b> N-PE; Neutral (TT Spark-Gap) <b>2P</b> 2+0; 1Ph+N (TNS,IT) <b>2PG</b> 1+1; 1Ph+N (TT) <b>3P</b> 3+0; 3Ph (TNC,IT) <b>4P</b> 4+0; 3Ph+N (TNS,IT) <b>4PG</b> 3+1; 3Ph+N (TT)	<b>M</b> Microswitch included

### Dimensions

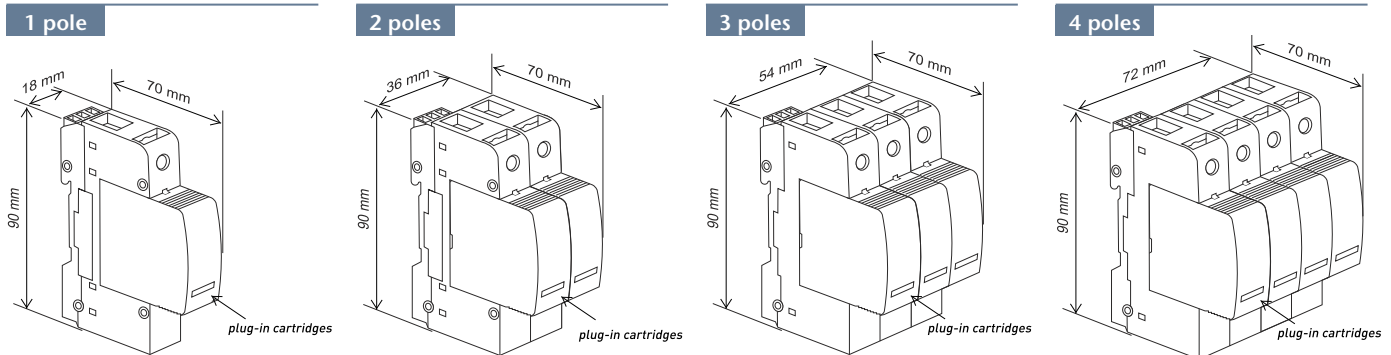

### Microswitch diagram

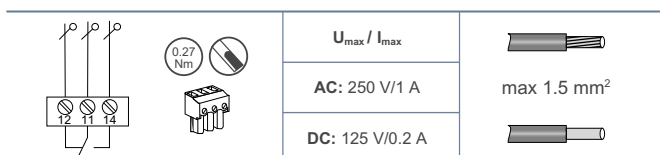



# Surge-Trap® Type 2 SPDs | STP T2 40

## Catalog numbers / Reference numbers

### 1 pole

Reference number	Catalog number	Network			Un [Vac]	Uc [V]	Imax(8/20) [kA]	In(8/20) [kA]	Up@In(8/20) [kV]	Remote (M)	Cartridge Id.	
		System type	Electrical diagram	L							N	
83020104	STPT2-40K150V-1P	L-N (1Ph)	A	120	150	40	20	≤0.9			C22	-
83020105	STPT2-40K150V-1PM	L-N (1Ph)	A	120	150	40	20	≤0.9	√		C22	-
83020106	STPT2-40K275V-1P	L-N (1Ph)	A	230	275	40	20	≤1.3			C23	-
83020107	STPT2-40K275V-1PM	L-N (1Ph)	A	230	275	40	20	≤1.3	√		C23	-
83020108	STPT2-40K320V-1P	L-N (1Ph)	A	277	320	40	20	≤1.4			C24	-
83020109	STPT2-40K320V-1PM	L-N (1Ph)	A	277	320	40	20	≤1.4	√		C24	-
83020110	STPT2-40K440V-1P	L-N (1Ph)	A	400	440	40	20	≤2			C25	-
83020111	STPT2-40K440V-1PM	L-N (1Ph)	A	400	440	40	20	≤2	√		C25	-
83020100	STPT2-30K750V-1P	L-N (1Ph)	A	690	750	40	15	≤3			C26	-
83020101	STPT2-30K750V-1PM	L-N (1Ph)	A	690	750	30	15	≤3	√		C26	-
83020112	STPT2-40K-N	N-PE (N)	B	Neutral	265	30	20	≤1.5			-	C27

### 2 poles

Reference number	Catalog number	Network			Un [Vac]	Uc [V]	Imax(8/20) [kA]	In(8/20) [kA]	Up@In(8/20) [kV]	Remote (M)	Cartridge Id.	
		System type	Electrical diagram	L							N	
83020128	STPT2-40K60V-2P	TNS (1Ph+N); PV	C	48/-	60; 65 Ucpv	40	20	≤0.7			C20	
83020129	STPT2-40K60V-2PM	TNS (1Ph+N); PV	C	48/-	60; 65 Ucpv	40	20	≤0.7	√		C20	
83020130	STPT2-40K75V-2P	TNS (1Ph+N); PV	C	60/-	75; 80 Ucpv	40	20	≤0.8			C21	
83020131	STPT2-40K75V-2PM	TNS (1Ph+N); PV	C	60/-	75; 80 Ucpv	40	20	≤0.8	√		C21	
83020114	STPT2-40K150V-2PG	TT (1Ph+N)	D	120/-	150	40	20	≤0.9 (L-N) ≤1.5 (N-PE)			C22	C27
83020115	STPT2-40K150V-2PGM	TT (1Ph+N)	D	120/-	150	40	20	≤0.9 (L-N) ≤1.5 (N-PE)	√		C22	C27
83020116	STPT2-40K275V-2PG	TT (1Ph+N)	D	230/-	275	40	20	≤1.3 (L-N) ≤1.5 (N-PE)			C23	C27
83020117	STPT2-40K275V-2PGM	TT (1Ph+N)	D	230/-	275	40	20	≤1.3 (L-N) ≤1.5 (N-PE)	√		C23	C27
83020118	STPT2-40K320V-2PG	TT (1Ph+N)	D	277/-	320	40	20	≤1.4 (L-N) ≤1.5 (N-PE)			C24	C27
83020119	STPT2-40K320V-2PGM	TT (1Ph+N)	D	277/-	320	40	20	≤1.4 (L-N) ≤1.5 (N-PE)	√		C24	C27
83020120	STPT2-40K150V-2P	TNS (1Ph+N)	F	120/-	150	40	20	≤0.9			C22	
83020121	STPT2-40K150V-2PM	TNS (1Ph+N)	F	120/-	150	40	20	≤0.9	√		C22	
83020122	STPT2-40K275V-2P	TNS (1Ph+N)	F	230/-	275	40	20	≤1.3			C23	
83020123	STPT2-40K275V-2PM	TNS (1Ph+N)	F	230/-	275	40	20	≤1.3	√		C23	
83020124	STPT2-40K320V-2P	TNS (1Ph+N)	F	277/-	320	40	20	≤1.4			C24	
83020125	STPT2-40K320V-2PM	TNS (1Ph+N)	F	277/-	320	40	20	≤1.4	√		C24	
83020126	STPT2-40K440V-2P	IT (1Ph+N); TNS(1Ph+N)	C	230/-; 400/-	440	40	20	≤2			C25	
83020127	STPT2-40K440V-2PM	IT (1Ph+N); TNS(1Ph+N)	C	230/-; 400/-	440	40	20	≤2	√		C25	

ELV

ELV Extra Low Voltage, also for use in DC Photovoltaic self-consumption / off-grid applications.

## Electrical diagrams

A (1P)

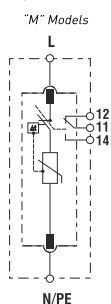

B (N)

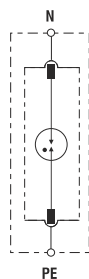

C 2+0 (2P)

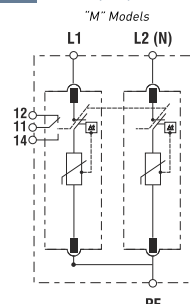

D 1+1 (2PG)

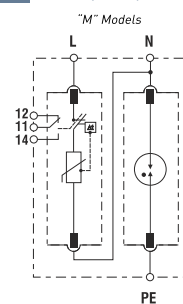

F 2+0 (2P)

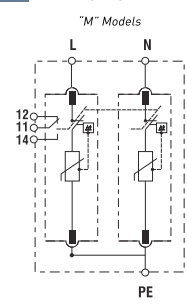

# Surge-Trap® Type 2 SPDs | STP T2 40

## 3 poles

Reference number	Catalog number	Network		Un [Vac]	Uc [V]	Imax(8/20) [kA]	In(8/20) [kA]	Up@In(8/20) [kV]	Remote (M)	Cartridge Id.	
		System type	Electrical diagram							L	N
83020132	STPT2-40K150V-3P	TNC (3Ph)	H	-/208	150	40	20	≤0.9		C22	-
83020133	STPT2-40K150V-3PM	TNC (3Ph)	H	-/208	150	40	20	≤0.9	√	C22	-
83020134	STPT2-40K275V-3P	TNC (3Ph)	H	-/400	275	40	20	≤1.3		C23	-
83020135	STPT2-40K275V-3PM	TNC (3Ph)	H	-/400	275	40	20	≤1.3	√	C23	-
83020136	STPT2-40K320V-3P	TNC (3Ph)	H	-/480	320	40	20	≤1.4		C24	-
83020137	STPT2-40K320V-3PM	TNC (3Ph)	H	-/480	320	40	20	≤1.4	√	C24	-
83020142	STPT2-40K440V-3P	IT (3Ph); TNC (3Ph)	I	-/400; -/690	440	40	20	≤2		C25	-
83020143	STPT2-40K440V-3PM	IT (3Ph); TNC (3Ph)	I	-/400; -/690	440	40	20	≤2	√	C25	-
83020102	STPT2-30K750V-3P	TNC (3Ph)	H	-/690; -/1000	750	30	15	≤3		C26	-
83020103	STPT2-30K750V-3PM	TNC (3Ph)	H	-/690; -/1000	750	30	15	≤3	√	C26	-

## 4 poles

Reference number	Catalog number	Network		Un [Vac]	Uc [V]	Imax(8/20) [kA]	In(8/20) [kA]	Up@In(8/20) [kV]	Remote (M)	Cartridge Id.	
		System type	Electrical diagram							L	N
83020144	STPT2-40K150V-4PG	TT (3Ph+N)	J	120/208	150	40	20	≤0.9 (L-N) ≤1.5 (N-PE)		C22	C27
83020145	STPT2-40K150V-4PGM	TT (3Ph+N)	J	120/208	150	40	20	≤0.9 (L-N) ≤1.5 (N-PE)	√	C22	C27
83020146	STPT2-40K275V-4PG	TT (3Ph+N)	J	230/400	275	40	20	≤1.3 (L-N) ≤1.5 (N-PE)		C23	C27
83020147	STPT2-40K275V-4PGM	TT (3Ph+N)	J	230/400	275	40	20	≤1.3 (L-N) ≤1.5 (N-PE)	√	C23	C27
83020148	STPT2-40K320V-4PG	TT (3Ph+N)	J	277/480	320	40	20	≤1.4 (L-N) ≤1.5 (N-PE)		C24	C27
83020149	STPT2-40K320V-4PGM	TT (3Ph+N)	J	277/480	320	40	20	≤1.4 (L-N) ≤1.5 (N-PE)	√	C24	C27
83020150	STPT2-40K150V-4P	TNS (3Ph+N)	L	120/208	150	40	20	≤0.9		C22	
83020151	STPT2-40K150V-4PM	TNS (3Ph+N)	L	120/208	150	40	20	≤0.9	√	C22	
83020152	STPT2-40K275V-4P	TNS (3Ph+N)	L	230/400	275	40	20	≤1.3		C23	
83020153	STPT2-40K275V-4PM	TNS (3Ph+N)	L	230/400	275	40	20	≤1.3	√	C23	
83020154	STPT2-40K320V-4P	TNS (3Ph+N)	L	277/480	320	40	20	≤1.4		C24	
83020155	STPT2-40K320V-4PM	TNS (3Ph+N)	L	277/480	320	40	20	≤1.4	√	C24	
83020156	STPT2-40K440V-4P	IT (3Ph+N); TNS (3Ph+N)	L	230/400; 400/690	440	40	20	≤2		C25	
83020157	STPT2-40K440V-4PM	IT (3Ph+N); TNS (3Ph+N)	L	230/400; 400/690	440	40	20	≤2	√	C25	

## Electrical diagrams

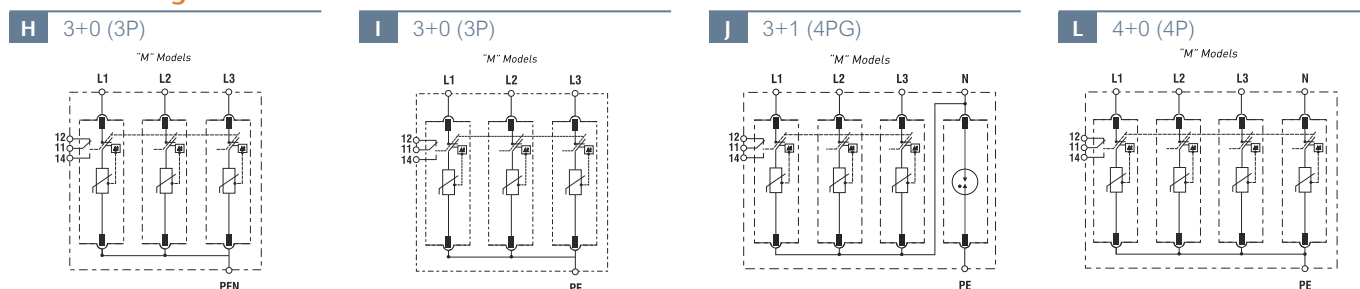

## Replacement cartridges

Reference number	Catalog number	Network	Un [Vac]	Uc [V]	Imax(8/20) [kA]	In(8/20) [kA]	Up@In(8/20) [kV]	Cartridge Id.
83020008	SP2-40K60V	L-N (1Ph)	48	60	40	20	≤0.7	C20
83020009	SP2-40K75V	L-N (1Ph)	60	75	40	20	≤0.8	C21
83020001	SP2-40K150V	L-N (1Ph)	120	150	40	20	≤0.9	C22
83020002	SP2-40K275V	L-N (1Ph)	230	275	40	20	≤1.3	C23
83020003	SP2-40K320V	L-N (1Ph)	277	320	40	20	≤1.4	C24
83020004	SP2-40K440V	L-N (1Ph)	400	440	40	20	≤2	C25
83020007	SP2-30K750V	L-N (1Ph)	690	750	30	15	≤3	C26
83020000	SP2-40K-N	N-PE (N)	Neutral	265	40	20	≤1.5	C27

# Surge-Trap® Type 2 Photovoltaic SPDs

Imax   
**40 kA**

## STP T2 40 PV

**STP T2 40 PV** is the series of devices that provide advanced overvoltage protection to photovoltaic systems by utilizing Mersen's optimized dynamic thermal disconnection system, which does not require additional overcurrent protection (back-up fuse) due to its high short-circuit withstand rating. These surge protective devices are suitable for all PV applications: large-scale, rooftop and self-consumption (off-grid) DC installations.

### Ratings and features

- Maximum discharge current (8/20µs): 40kA
- Nominal discharge current (8/20µs): 20kA
- Ucpv: 65, 80, 660, 1060 Vdc and 1500Vdc (soon available)
- Iscpv: 10kA (EN-50539-11), no back-up fuse required
- SCCR: 50kA, 100kA (UL 1449 3rd Ed)
- DIN-rail mountable, plug-in format
- Visual and remote end of life indicators



ep.mersen.com

No back-up fuse required



### Approvals/Standards

- EN-50539-11
- UTE C 61740-51
- UL 1449 3rd Ed recognized, File No. E468946



GUIDE

Example

## STP T2 - 40K 1000V - YPV M

**Surge-Trap® Pluggable Type 2 / Class II surge protective device (8/20µs)**

### Step 1

Max. discharge current  
**40K** Imax (L-N) =40kA

### Step 2

Operating voltage

Value	Ucpv
<b>600V</b>	660Vdc
<b>1000V</b>	1060Vdc
<b>1200V</b>	1200Vdc
<b>1500V</b>	1500Vdc

### Step 3

Network configuration  
**YPV** L+/L-; "Y" configuration (Photovoltaic DC)

### Step 4

Remote monitoring  
**M** Microswitch included

### Catalog numbers / Reference numbers

Reference number	Catalog number	Network							Remote (M)	Cartridge Id.	
		System type	Electrical diagram	Ucpv [Vdc]	Iscpv [A]	Imax(8/20) [kA]	In(8/20) [kA]	Up@In(8/20) [kV]		L	
83020138	STPT2-40K600V-YPV	"Y" PV	A	660	10 000	40	20	≤2.6		C40	
83020139	STPT2-40K600V-YPVM	"Y" PV	A	660	10 000	40	20	≤2.6	√	C40	
83020140	STPT2-40K1000V-YPV	"Y" PV	A	1060	10 000	40	20	≤4		C41	
83020141	STPT2-40K1000V-YPVM	"Y" PV	A	1060	10 000	40	20	≤4	√	C41	

Remark: see also page 17 "2 poles" for DC self-consumption "off-grid" applications **ELV** (extra low voltage). Consult us for other voltages

### Dimensions

3 modules

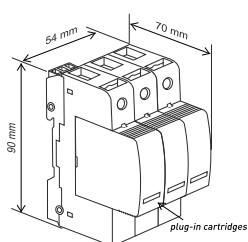

### Electrical diagram

A Y PV

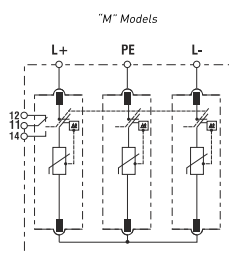

### Replacement cartridges

Ref. number	Catalog number	Network	Ucpv [Vdc]	Imax (8/20) [kA]	In(8/20) @Up [kA]	Up@In(8/20) [kV]	Cartridge Id.
83020005	SP2-40K600V-PV	PV	330	40	20	≤1.3	C40
83020006	SP2-40K1000V-PV	PV	530	40	20	≤2	C41

### Microswitch diagram

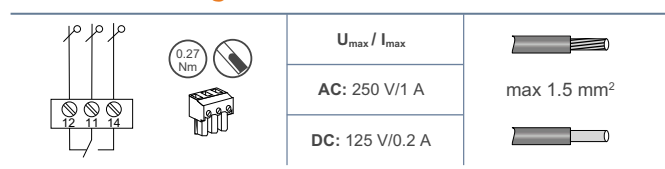

# Surge-Trap® Type 2+3 SPDs

Imax   
20 kA

## STP T23 20

**STP T23 20** is the series of combined Type 2+3/Class II+III devices for discharging voltage surges while providing a very fine voltage protection level, in accordance with EN/IEC 61643. Suitable as the final stage of protection in panels with Type 2 protection devices installed upstream such as STP T2 40 SPDs. These SPDs should be installed as close as possible to the equipment being protected.

### Ratings and features

- Maximum discharge current (8/20µs): 20kA per phase
- Nominal discharge current (8/20µs): 10kA per phase
- Combined voltage pulse Uoc (1.2/50µs): 10kV
- TNS, TNC, TT and IT networks
- Un(L-N/L-L): 120/208V, 230/400V, 277/480V and 400/690V
- PLC friendly solutions (LCF) for Power Line Communications
- DIN-rail mountable, plug-in format
- Visual and remote end of life indicators
- Reversible chassis to allow cable entry from above or below
- Mechanically coded cartridges to avoid cartridge replacement errors



### Approvals/Standards

- IEC/EN 61643
- CE



GUIDE

Example

## STP T23 - 20K 275V - 4PG LF M

**Surge-Trap® Pluggable Type 2+3 / Class II+III surge protective device (8/20µs) and very fine protection of equipment (1.2/50µs)**

Step 1	Step 2	Step 3	Step 4	Step 5
Max. discharge current	Operating voltage	Network configuration	Additional features	Remote monitoring
<b>20K</b> I <sub>max</sub> (L-N) =20kA	<b>Uc</b> <b>Un (L-N/L-L)</b>	<b>1P</b> L-N; 1Ph (TNS,TNC,IT,TT) <b>N</b> N-PE; Neutral (TT Spark-Gap)	<b>LF</b> Leakage current free	<b>M</b> Microswitch included
	<b>150V</b> 120/208V <b>275V</b> 230/400V (for LF models only) <b>320V</b> 230/400; 277/480V <b>440V</b> 230/400V "IT" 400/690V <b>Blank</b> N-PE protection	<b>2P</b> 2+0; 1Ph+N (TNS) <b>2PG</b> 1+1; 1Ph+N (TT) <b>3P</b> 3+0; 3Ph (TNC) <b>4P</b> 4+0; 3Ph+N (TNS) <b>4PG</b> 3+1; 3Ph+N (TT)		

### Dimensions

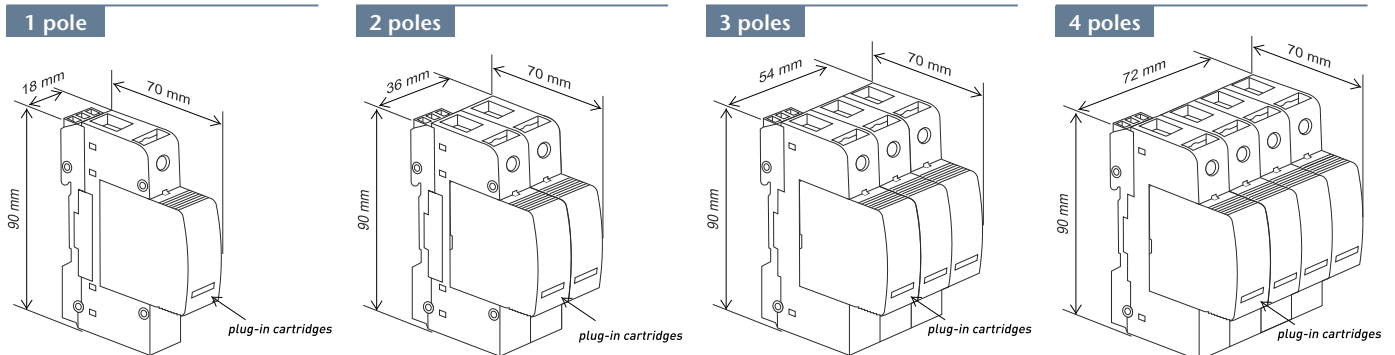

### Microswitch diagram

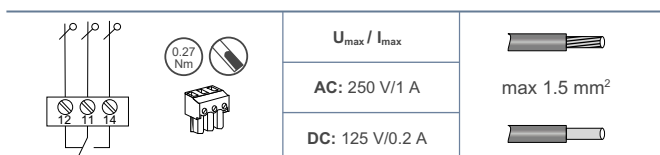

# Surge-Trap® Type 2+3 SPDs | STP T23 20

## Catalog numbers / Reference numbers

### 1 pole

Reference number	Catalog number	Network								Cartridge Id.		
		System type	Electrical diagram	Un [Vac]	Uc [V]	I <sub>max</sub> (8/20) [kA]	In(8/20) [kA]	U <sub>oc</sub> [kV]	Up@In(8/20) [kV]	Remote (M)	L	N
83230100	STPT23-20K150V-1P	L-N (1Ph)	A	120	150	20	10	10	≤0.8		C60	-
83230101	STPT23-20K150V-1PM	L-N (1Ph)	A	120	150	20	10	10	≤0.8	√	C60	-
83230102	STPT23-20K320V-1P	L-N (1Ph)	A	230; 277	320	20	10	10	≤1.4		C62	-
83230103	STPT23-20K320V-1PM	L-N (1Ph)	A	230; 277	320	20	10	10	≤1.4	√	C62	-
83230104	STPT23-20K440V-1P	L-N (1Ph)	A	400	440	20	10	10	≤2		C63	-
83230105	STPT23-20K440V-1PM	L-N (1Ph)	A	400	440	20	10	10	≤2	√	C63	-
83230106	STPT23-20K-N	N-PE (N)	B	Neutral	255	20	10	10	≤1.5		-	C64

### 2 poles

Reference number	Catalog number	Network								Cartridge Id.		
		System type	Electrical diagram	Un [Vac]	Uc [V]	I <sub>max</sub> (8/20) [kA]	In(8/20) [kA]	U <sub>oc</sub> [kV]	Up@In(8/20) [kV]	Remote (M)	L	N
83230108	STPT23-20K150V-2PG	TT (1Ph+N)	D	120/-	150	20	10	10	≤0.8 (L-N) ≤1.5 (N-PE)		C60	C64
83230109	STPT23-20K150V-2PGM	TT (1Ph+N)	D	120/-	150	20	10	10	≤0.8 (L-N) ≤1.5 (N-PE)	√	C60	C64
83230112	STPT23-20K320V-2PG	TT (1Ph+N)	D	230/-; 277/-	320	20	10	10	≤1.4 (L-N) ≤1.5 (N-PE)		C62	C64
83230113	STPT23-20K320V-2PGM	TT (1Ph+N)	D	230/-; 277/-	320	20	10	10	≤1.4 (L-N) ≤1.5 (N-PE)	√	C62	C64
83230110	STPT23-20K275V-2PG-LF	TT (1Ph+N)	E	230/-	275	20	10	10	≤1.5 (L-N) ≤1.5 (N-PE)		C61	C64
83230111	STPT23-20K275V-2PG-LFM	TT (1Ph+N)	E	230/-	275	20	10	10	≤1.5 (L-N) ≤1.5 (N-PE)	√	C61	C64
83230114	STPT23-20K150V-2P	TNS (1Ph+N)	F	120/-	150	20	10	10	≤0.8		C60	
83230115	STPT23-20K150V-2PM	TNS (1Ph+N)	F	120/-	150	20	10	10	≤0.8	√	C60	
83230116	STPT23-20K320V-2P	TNS (1Ph+N)	F	230/-; 277/-	320	20	10	10	≤1.4		C62	
83230117	STPT23-20K320V-2PM	TNS (1Ph+N)	F	230/-; 277/-	320	20	10	10	≤1.4	√	C62	
83230134	STPT23-20K275V-2P-LF	TNS (1Ph+N)	G	230/-	275	20	10	10	≤1.5		C61	
83230135	STPT23-20K275V-2P-LFM	TNS (1Ph+N)	G	230/-	275	20	10	10	≤1.5	√	C61	

## Electrical diagrams

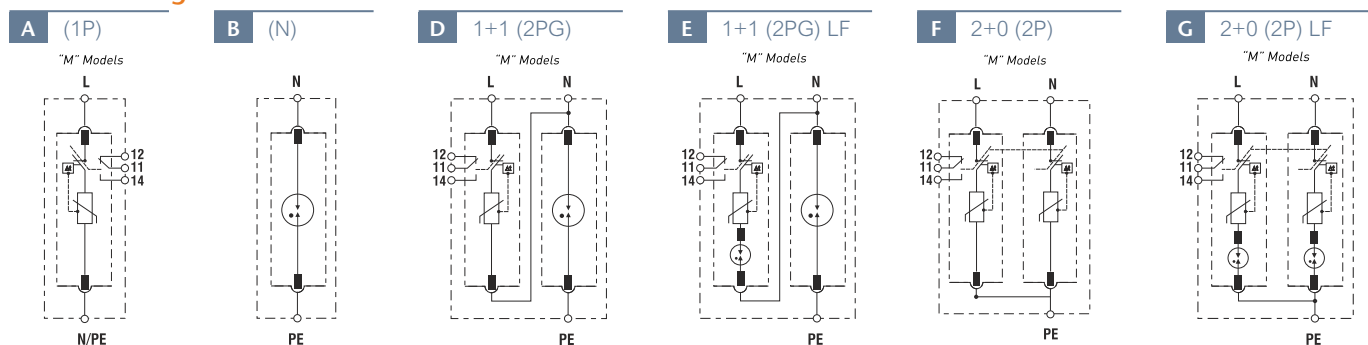

# Surge-Trap® Type 2+3 SPDs | STP T23 20

## 3 poles

Reference number	Catalog number	Network		Un [Vac]	Uc [V]	Imax(8/20) [kA]	In(8/20) [kA]	Uoc [kV]	Up@In(8/20) [kV]	Remote (M)	Cartridge Id.	
		System type	Electrical diagram								L	N
83230118	STPT23-20K150V-3P	TNC (3Ph)	H	-/208	150	20	10	10	≤0.8		C60	-
83230119	STPT23-20K150V-3PM	TNC (3Ph)	H	-/208	150	20	10	10	≤0.8	√	C60	-
83230122	STPT23-20K320V-3P	TNC (3Ph)	H	-/400; -/480	320	20	10	10	≤1.4		C62	-
83230123	STPT23-20K320V-3PM	TNC (3Ph)	H	-/400; -/480	320	20	10	10	≤1.4	√	C62	-
83230120	STPT23-20K275V-3P-LF	TNC (3Ph)	N	-/400	275	20	10	10	≤1.5		C61	-
83230121	STPT23-20K275V-3P-LFM	TNC (3Ph)	N	-/400	275	20	10	10	≤1.5	√	C61	-

## 4 poles

Reference number	Catalog number	Network		Un [Vac]	Uc [V]	Imax(8/20) [kA]	In(8/20) [kA]	Uoc [kV]	Up@In(8/20) [kV]	Remote (M)	Cartridge Id.	
		System type	Electrical diagram								L	N
83230124	STPT23-20K150V-4PG	TT (3Ph+N)	J	120/208	150	20	10	10	≤0.8 (L-N) ≤1.5 (N-PE)		C60	C64
83230125	STPT23-20K150V-4PGM	TT (3Ph+N)	J	120/208	150	20	10	10	≤0.8 (L-N) ≤1.5 (N-PE)		C60	C64
83230128	STPT23-20K320V-4PG	TT (3Ph+N)	J	230/400; 277/480	320	20	10	10	≤1.4 (L-N) ≤1.5 (N-PE)		C62	C64
83230129	STPT23-20K320V-4PGM	TT (3Ph+N)	J	230/400; 277/480	320	20	10	10	≤1.4 (L-N) ≤1.5 (N-PE)	√	C62	C64
83230126	STPT23-20K275V-4PG-LF	TT (3Ph+N)	K	230/400	275	20	10	10	≤1.5 (L-N) ≤1.5 (N-PE)		C61	C64
83230127	STPT23-20K275V-4PG-LFM	TT (3Ph+N)	K	230/400	275	20	10	10	≤1.5 (L-N) ≤1.5 (N-PE)	√	C61	C64
83230130	STPT23-20K150V-4P	TNS (3Ph+N)	L	120/208	150	20	10	10	≤0.8		C60	
83230131	STPT23-20K150V-4PM	TNS (3Ph+N)	L	120/208	150	20	10	10	≤0.8	√	C60	
83230132	STPT23-20K320V-4P	TNS (3Ph+N)	L	230/400; 277/480	320	20	10	10	≤1.4		C62	
83230133	STPT23-20K320V-4PM	TNS (3Ph+N)	L	230/400; 277/480	320	20	10	10	≤1.4	√	C62	
83230136	STPT23-20K275V-4P-LF	TNS (3Ph+N)	M	230/400	275	20	10	10	≤1.5		C61	
83230137	STPT23-20K275V-4P-LFM	TNS (3Ph+N)	M	230/400	275	20	10	10	≤1.5	√	C61	

## Electrical diagrams

**H** 3+0 (3P)

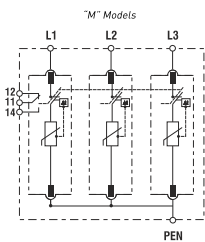

**N** 3+0 (3P) LF

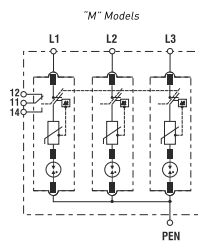

**J** 3+1 (4PG)

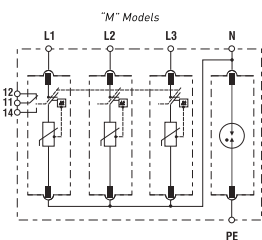

**K** 3+1 (4PG) LF

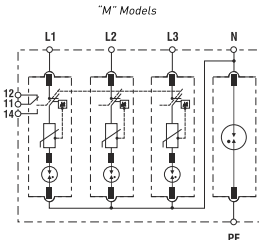

**L** 4+0 (4P)

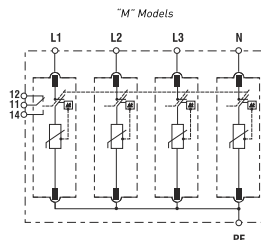

**M** 4+0 (4P) LF

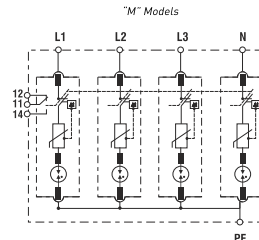

## Replacement cartridges

Reference number	Catalog number	Network	Un [Vac]	Uc [V]	Imax(8/20) [kA]	In(8/20) [kA]	Uoc [kV]	Up@In(8/20) [kV]	Cartridge Id.
83230001	SP23-20K150V	L-N (1Ph)	120	150	20	10	10	≤0.8	C60
83230003	SP23-20K275V-LF	L-N (1Ph)	230	275	20	10	10	≤1.3	C61
83230002	SP23-20K320V	L-N (1Ph)	230; 277	320	20	10	10	≤1.4	C62
83230004	SP23-20K440V	L-N (1Ph)	400	440	20	10	10	≤2	C63
83230000	SP23-20K-N	N-PE (N)	Neutral	255	20	10	10	≤1.5	C64

# Surge-Trap® Type 2+3 SPDs

Imax   
20 kA

## STM T23 20 S

**STM T23 20 S** is the series of combined Type 2+3/Class II+III devices for discharging voltage surges while providing a very fine voltage protection level, in accordance with EN/IEC 61643. Suitable as the final stage of protection in panels with Type 2 protection devices installed upstream. These SPDs should be installed as close as possible to the equipment being protected. Ideal for limited spaces. Wide range of voltage ratings.

### Ratings and features

- Maximum discharge current (8/20µs): 20kA, 6kA
- Nominal discharge current (8/20µs): 10kA, 3kA
- Combined voltage pulse (1.2/50µs): 10kV, 6kV
- Single phase TT and TNS networks
- Un: 12V, 24V, 48V, 60V, 120V, 230V
- Typically for use also in the corresponding DC voltages
- DIN-rail mountable, monobloc format
- Visual (LED) and remote end of life indicators
- Power status (LED) indicator
- Space saving "slim" format



ep.mersen.com

### Approvals/Standards

- IEC/EN 61643
- CE



GUIDE

Example

## STM T23 - 20K 275V - SP - S M

**Surge-Trap®  
Type 2+3 / Class II+III**  
surge protective device  
(8/20µs) and very fine  
protection of equipment  
(1.2/50µs)

Step 1	Step 2	Step 3	Step 4	Step 5
Max. discharge current	Operating voltage	Network configuration	Additional features	Remote monitoring
<b>6K</b> I <sub>max</sub> (L-N) =6kA <b>20K</b> I <sub>max</sub> (L-N) =20kA	<b>U<sub>c</sub></b> <b>U<sub>n</sub> (L-N)</b>	<b>SP</b> Single Phase; 1Ph+N (TT,TNS)	<b>S</b> Slim - space saving	<b>M</b> Microswitch included
	<b>20V</b> 12V <b>30V</b> 24V <b>60V</b> 48V <b>75V</b> 60V <b>150V</b> 120V <b>230V</b> 230V			

### Catalog numbers / Reference numbers

#### 2 poles

Reference number	Catalog number without remote monit.	Catalog number with remote monit.	Network							
			System type	Electrical diagram	U <sub>n</sub> [Vac]	U <sub>c</sub> [V]	I <sub>max</sub> (8/20) [kA]	I <sub>n</sub> (8/20) [kA]	U <sub>oc</sub> [kV]	U <sub>p</sub> @I <sub>n</sub> (8/20) [kV]
83230500 83230501	STMT23-6K20V-SP-S	STMT23-6K20V-SP-SM	TT/TNS (1Ph+N)	A	12	20	6	3	6	≤0.22 (L1-L2) 0.7 (L1/L2-PE)
83230504 83230505	STMT23-6K30V-SP-S	STMT23-6K30V-SP-SM	TT/TNS (1Ph+N)	A	24	30	6	3	6	≤0.22 (L1-L2) 0.7 (L1/L2-PE)
83230506 83230507	STMT23-6K60V-SP-S	STMT23-6K60V-SP-SM	TT/TNS (1Ph+N)	A	48	60	6	3	6	≤0.33 (L1-L2) 0.7 (L1/L2-PE)
83230508 83230509	STMT23-6K75V-SP-S	STMT23-6K75V-SP-SM	TT/TNS (1Ph+N)	A	60	75	6	3	6	≤0.5 (L1-L2) 0.9 (L1/L2-PE)
83230502 83230503	STMT23-6K150V-SP-S	STMT23-6K150V-SP-SM	TT/TNS (1Ph+N)	A	120	150	6	3	6	≤0.7 (L1-L2) 0.9 (L1/L2-PE)
83230510 83230511	STMT23-20K275V-SP-S	STMT23-20K275V-SP-SM	TT/TNS (1Ph+N)	A	230	275	20	10	10	≤1.4 (L1-L2) 1.4 (L1/L2-PE)

### Dimensions

#### 2 poles

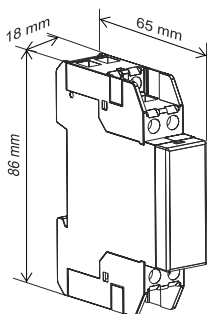

### Electrical diagram

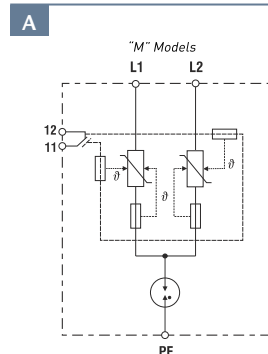

### Microswitch diagram

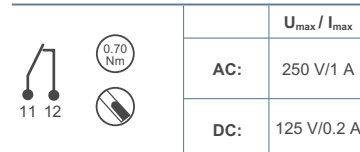

# Surge-Trap® Type 2+3 SPDs

Imax   
20 kA



ep.mersen.com

## STE T23 20

**STE T23 20** is the series of combined Type 2+3/Class II+III devices for discharging voltage surges while providing a very fine voltage protection level, in accordance with EN/IEC 61643. Complete with a built-in powerful EMI filter. Suitable as the final stage of protection in installations with electromagnetic disturbances which might interrupt, degrade or limit system performance. Series connection for applications up to 20A rated current.

### Ratings and features

- Maximum discharge current (8/20µs): 20kA
- Nominal discharge current (8/20µs): 10kA
- Combined voltage pulse (1.2/50µs): 6kV
- Filter attenuation up to 82dB (common mode)
- Rated current load (IL): 20A
- Single phase TT and TNS networks
- Un: 120V, 230V
- DIN-rail mountable, monobloc format
- Visual (LED) and remote end of life indicators
- Power status (LED) indicator



### Approvals/Standards

- IEC/EN 61643
- CE



GUIDE

Example

## STE T23 - 20K 275V - SP M

**Surge-Trap® Type 2+3 / Class II+III** surge protective device (8/20µs) and very fine protection of equipment (1.2/50µs). With EMI filter

Step 1	Step 2	Step 3	Step 4
Max. discharge current	Operating voltage	Network configuration	Remote monitoring
<b>20K</b> I <sub>max</sub> (L-N) = 20kA	<b>U<sub>c</sub></b> <b>U<sub>n</sub> (L-N)</b>	<b>SP</b> Single Phase; 1Ph+N (TT,TNS)	<b>M</b> Microswitch included
	<b>150V</b> 120V <b>275V</b> 230V		

### Catalog numbers / Reference numbers

#### 2 poles

Reference number	Catalog number	Network		U <sub>n</sub> [Vac]	U <sub>c</sub> [V]	I <sub>max</sub> (8/20) [kA]	I <sub>n</sub> (8/20) [kA]	U <sub>oc</sub> [kV]	U <sub>p</sub> [kV]	I <sub>L</sub> [A]	Remote (M)
		System type	Electrical diagram								
83230401	STET23-20K150V-SPM	TT/TNS (1Ph+N)	A	120	150	20	10	6	≤0.8	20	✓
83230403	STET23-20K275V-SPM	TT/TNS (1Ph+N)	A	230	275	20	10	6	≤1.2	20	✓

### Dimensions

2 poles

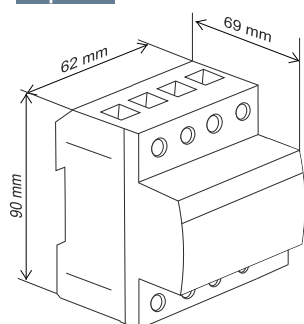

### Electrical diagram

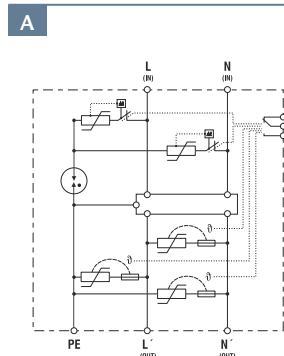

### Microswitch diagram

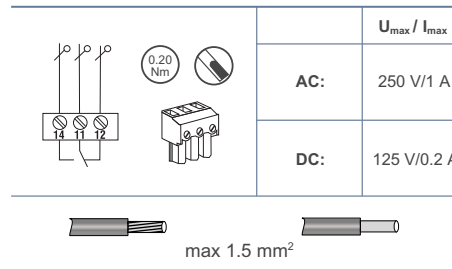



# Surge-Trap® Type 2+3 SPDs

Uoc   
**10 kV**



[ep.mersen.com](http://ep.mersen.com)

## STL T23 10

**STL T23 10** is the series of robust 10kV combined Type 2+3/ Class II+III devices for discharging voltage surges while providing a very fine voltage protection level, in accordance with EN/IEC 61643. Suitable for protection of LED outdoor luminaires (street-light). Due to the exposure of the extremely sensitive LED electronics to lightning-induced overvoltages, STL T23 10 is a widespread market solution amongst OEM manufacturers of LED lighting systems.

### Ratings and features

- Combined voltage pulse (1.2/50µs): 10kV (Uoc)
- Maximum discharge current (8/20µs): 10kA
- Nominal discharge current (8/20µs): 5kA
- Class 1 and Class 2 luminaires, universal solutions
- Miniature size and easy to install
- Hardwired, in-line format
- End of life indication
- Rated current load (IL): 10A (series)
- Optional: "surge tested and certified" luminaire with STL T23 10 by accredited LAB



### Approvals/Standards

- IEC/EN 61643
- CE
- CB scheme



GUIDE

Example

## STL 23 - 10K 320V - C12

**Surge-Trap®**  
**Type 2+3 / Class II+III**  
surge protective device (8/20µs) and very fine protection of equipment (1.2/50µs). For lighting LED luminaire

### Step 1

Combined voltage pulse

**10K** Uoc: 10kV

### Step 2

Operating voltage

Uc	Un (L-N)
<b>320V</b>	230V

### Step 3

Insulation category of the outdoor luminaire

- C1** Class 1
- C12** Class 1 and 2
- C2** Class 2

### Catalog numbers / Reference numbers

Reference number	Catalog number	Network		Un [Vac]	Uc [V]	Imax(8/20) [kA]	In(8/20) [kA]	Uoc [kV]	Up@In(8/20) [kV]	IL [A]
		System type	Electrical diagram							
83230300	STLT23-10K320V-C1	C1 (1Ph+N)	A	230	320	10	5	10	≤1.5 (L1-L2) ≤1.8 (L1/L2-PE)	10
83230302	STLT23-10K320V-C12	C12 (1Ph+N)	B	230	320	10	5	10	≤1.5 (L1-L2) ≤1.8 (L1/L2-GND)	10
83230301	STLT23-10K320V-C2	C2 (1Ph+N)	C	230	320	10	5	10	≤1.5 (L1-L2)	10

### Dimensions

ALL

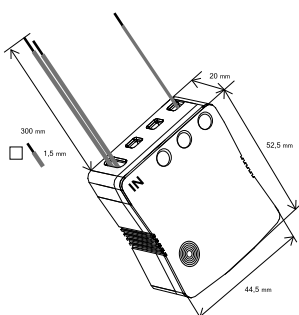

### Electrical diagrams

A C1

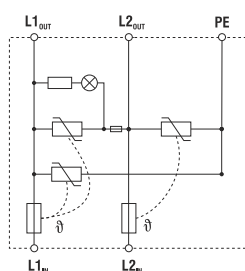

B C12

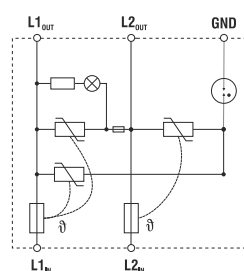

C C2

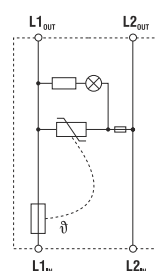

# Smart solutions for protection of remote sites

## SMART AUTOMATIC RECLOSER



### Full protection

- POP / TOV temporary overvoltage and undervoltage
- Phase sequence fault
- RCD earth leakage
- MCB overcurrent

### Event logging

### Automatic reclosing

### Compact pre-wired, plug & play



**POP / TOV**  
temporary overvoltage  
EN 50550



**Phase sequence**  
fault



**RCD**  
earth leakage



**MCB**  
overcurrent

These are programmable, motorized devices, comprising a monitoring unit and a circuit breaker (autorecloser) that disconnect the supply when the values of voltage, current or earth leakage exceed predefined thresholds. **These devices are automatically reclosed** when the values return to within the allowable limits.

- The pre-wired **plug and play** autorecloser, compact and installable on DIN rail, allows for **quick and easy connection**.

- The smart autorecloser provides **maximum continuity of service** and is ideal for 24x7 installations with remote locations.
- **Memory with an error log**, as well as remote operation (remote reset function) and remote indication.
- 6 to 63 A circuit breakers, single phase (P+N) and 3-phase (4P), for 120 V and 230 V. Consult us for other configurations.



## CONTINUOUS GROUND MONITOR

An SPD is only as efficient as the ground connection

24x7 checking of the earth-loop

Easy, NO extra earth rods required

Complementary with maintenance earth testing

Know your grounding status in real-time

100% security

Detecting

- Aging of earth rods
- Cable theft
- Soil resistance (dry seasons)
- Breakage / bad connection

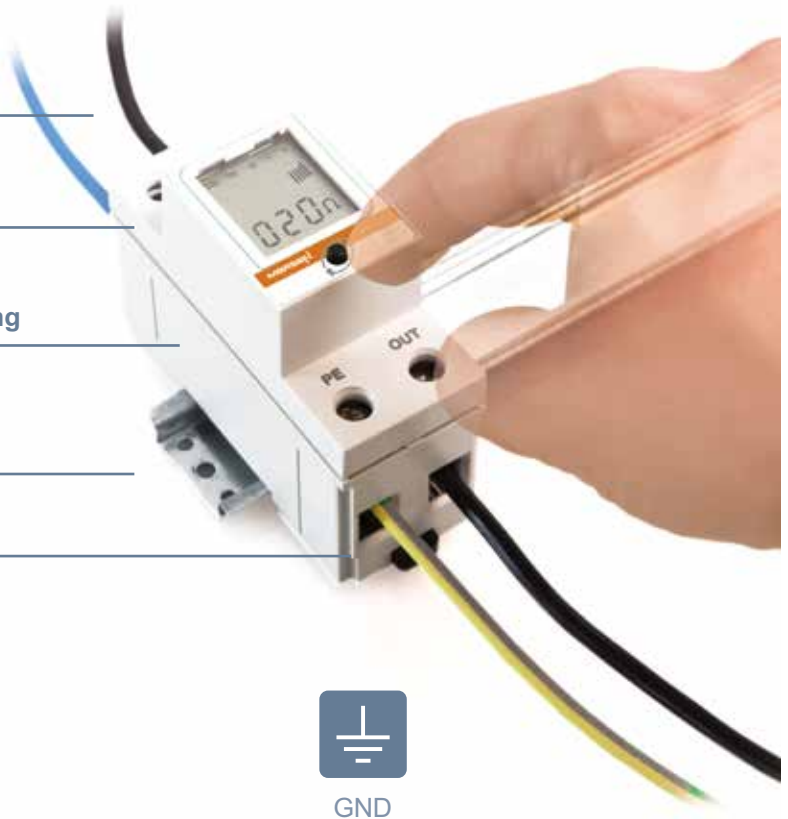

This device continuously monitors the state of the ground connection:

- Ensures **proper operation of surge protection devices**, discharging energy through the facility ground.
- Ensures the **protection of personnel against indirect contacts**.
- Reduces cost of preventative maintenance.

By the method of calculating the loop resistance, it checks the impedance of the actual path of an indirect contact leakage, for **detecting the following possible incidents**, both within the installation and in the transformation centre to which it is connected:

- Deterioration of the ground connection** due to aging of the earth rods, theft of the cables or increasing soil resistivity in dry seasons.
- Breakage or bad connection of the neutral wire.**



Wiring diagram

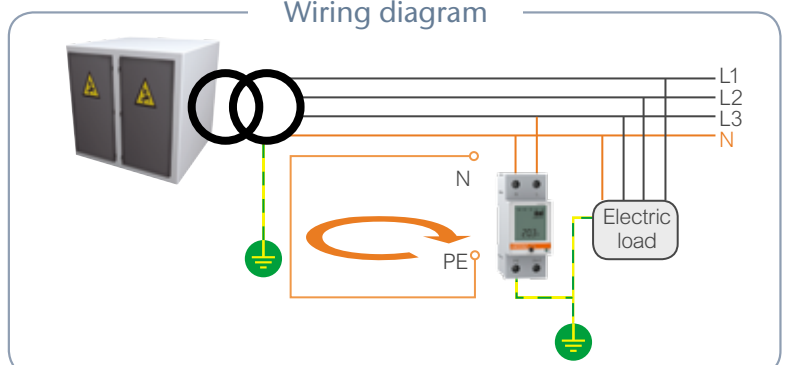



**A WORLD LEADER  
in safety & reliability  
for electrical power**

## A GLOBAL PLAYER

Global expert in materials and equipment for extreme environments and in the safety and reliability of electrical equipment.

Mersen designs innovative solutions to address its clients' specific needs to enable them to optimize their manufacturing process in sectors such as Energy, Transportation, Electronics, Chemical, Pharmaceutical and Process Industries.

**MERSEN FRANCE SB  
S.A.S.**  
Rue Jacques de Vaucanson  
F-69720 Saint-Bonnet-de-Mure  
Phone: + 33 4 72 22 66 11

**MERSEN SHANGHAI CO.  
LTD.**  
No.55-A6. Shu Shan Road,  
Songjiang201611 Shanghai  
Phone: + 8621 67602388

**MERSEN USA  
Newburyport-MA L.L.C.**  
374 Merrimac Street  
Newburyport, MA 01950  
Phone: 978-462-6662

[ep.mersen.com](http://ep.mersen.com)