

# SHORT CIRCUITS: A GUIDE TO TERMINOLOGY AND BASIC CALCULATIONS

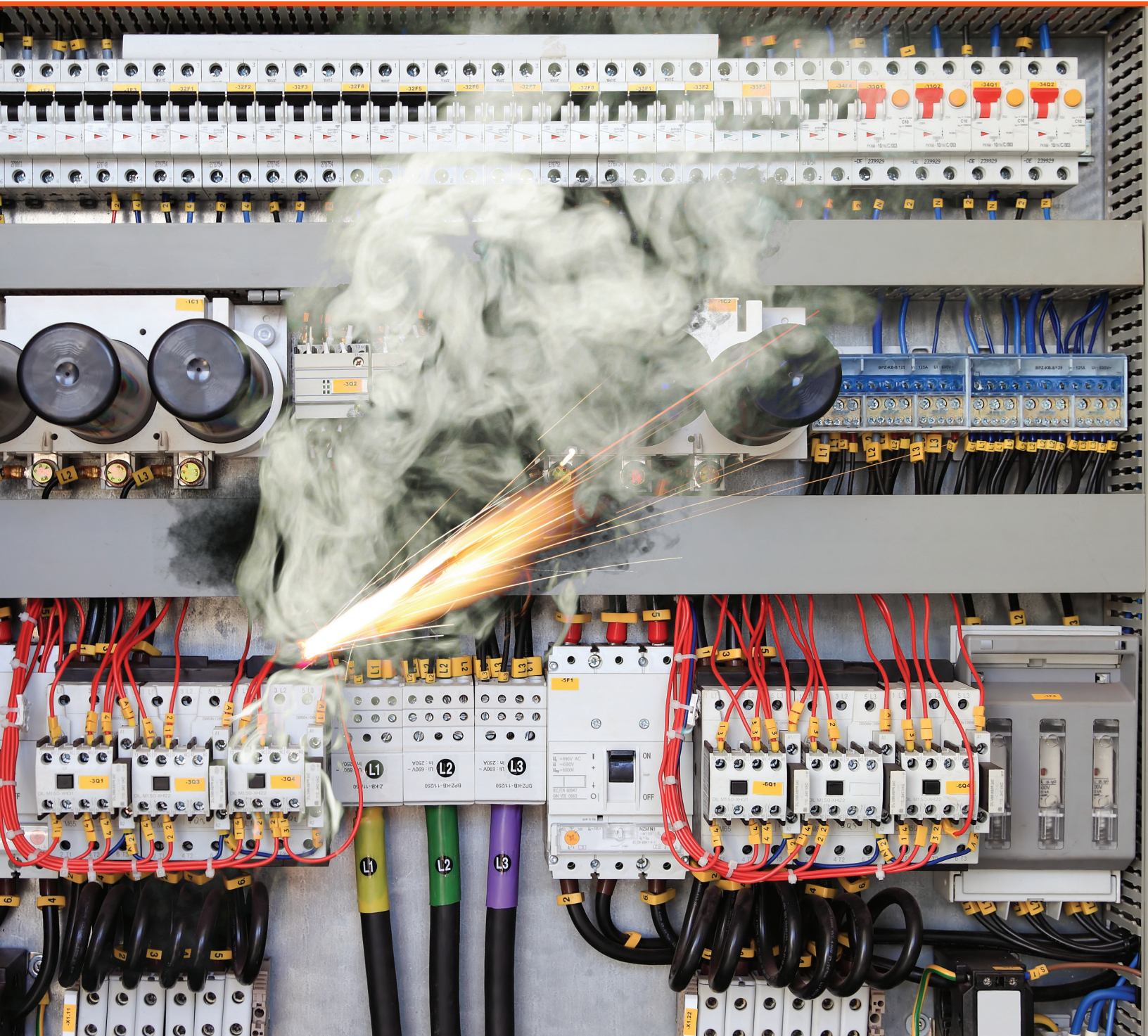

## RESPONSIBILITY

There are many requirements in the National Electrical Code® which pertain to overcurrent protection. These articles provide for equipment and personnel protection. In order to comply with these requirements there is certain information that must be known, such as the value of short-circuit current which can flow through equipment when an electrical fault occurs.

The intent of this guide is to provide a means for estimating the numerical value of the short-circuit current. Once this value is known, safe intelligent protection of personnel and equipment can be accomplished. This booklet is not intended to replace more sophisticated methods such as system analysis software.

The responsibility for meeting Code requirements is everybody's business. It belongs with the specifying engineer, the manufacturer, the contractor, and ultimately with the inspector who has the last word.

It is the inspector who needs to know what equipment to consider for short circuits and how big they will all be. In other words, the inspector must know the available short-circuit current at each fuse and circuit breaker location in order to determine the minimum interrupting rating required as well as the minimum short-circuit current rating (SCCR) of the equipment.

The determination may be as simple as asking the utility company how much short-circuit current is available at the service entrance or getting all the answers from a specifying engineer. In real life, inspectors must make on-the-spot determinations based on an understanding of what to look for and the ability to talk short-circuit language.

## INTERRUPTING RATING

Article 110.9 deals with two levels of current:

- “current at fault levels”
- “current at other than fault levels”

“Currents at fault levels” include short-circuit currents known as phase to phase and phase to ground faults. “Currents at other than fault levels” include current ratings marked on equipment such as switches, relays, or contactors that need only interrupt normal load currents.

This guide deals with short-circuit currents and therefore with the first requirement of 110.9. Recognition of equipment having “an interrupting rating sufficient for the current available at the line terminals” requires knowledge of available short-circuit currents such as where to expect them, where they come from and how to determine their size. They can vary from a few hundred to a few hundred thousand amperes.

## CIRCUIT IMPEDANCE AND OTHER CHARACTERISTICS

Article 110.10 discusses circuit impedance and other characteristics, but this guide deals only with “the equipment short-circuit ratings” and the extent of damage to components.

Since 2011, the National Electrical Code has steadily increased requirements for installed equipment to have short-circuit current ratings. As of this update, Service Disconnect Switches, Surge Protective Devices, Switchboards, Switchgear, and Panelboards, Industrial Control Panels, Motor Controllers, Elevators, Industrial Machinery, and Transfer Equipment are all required to have short-circuit current ratings. Most power components utilized in the equipment described above will have short-circuit current ratings as required by Underwriters Laboratories (UL). Busways have short-circuit current ratings but UL and industry standards do not require marked ratings. These ratings can usually be obtained from manufacturers. Some residential meters and metering equipment have marked short-circuit ratings. Withstand ability is sometimes expressed by  $I_p$  and  $I^2t$ . Only fuses have standardized let-thru ratings based on  $I_p$  and  $I^2t$ .



## NONINTERCHANGEABLE

NEC 240.60(B) is a design requirement and UL listed fuses and fuse holders automatically provide the non-interchangeability required by the Code. All UL listed fuse holders intended for current-limiting fuses have inherent rejection features and physically prevent installation of fuses which are not marked “current limiting” as a part of the UL marking requirements.

## MARKING

UL requirements for fuses and circuit breakers align with NEC Articles 240.60(C) and 240.83(C). This means that fuses and circuit breakers with no marked interrupting ratings are automatically rated 10,000 and 5,000 amperes respectively. UL has three levels of interrupting ratings for fuses above the unmarked 10,000 ampere level, 50,000, 100,000 and 200,000 amperes.

Modern applications utilize UL Class L, Class R, Class J and Class CC fuses which have only one interrupting rating, 200,000 amperes which provides increased system safety. No fuse should ever be installed without knowing the available short-circuit current, and that the short-circuit rating of the fuse is equal to or greater than this available current.

NEC 240.67 and 240.87 has requirements that deal with Arcing fault currents ( $I_{arc}$ ). These currents are lower-level short circuit currents that can be carried across air between energized parts. The calculation of arcing currents begins with calculating the short-circuit current ( $I_{bf}$ ). This guide does not discuss how  $I_{arc}$  is derived from  $I_{bf}$ . Methods for that can be obtained in IEEE 1584 or NFPA 70E.

It is not the intent of this guide to offer a new approach to this subject or add to the vast amount of material already available on short-circuit calculations, or for that matter even adequately cover the subject in a simple presentation. This guide is limited to a discussion of the principles involved, the phraseology used and a few illustrations, examples and tables which are readily understandable, and which do not require an extensive knowledge of mathematics. For complex mathematical methods, other sources such as IEC 60909, IEEE 3002.3, ANSI C37.10. etc. should be consulted.

**Section I -** Describes the **various sources of short-circuit current**, including a simple summary of transformers and voltages which cannot supply short-circuit currents greater than 10,000 amperes.

**Section II - Short Circuit Terminology** describes the terminology and basics of short-circuit analysis and component protection in layman’s language.

**Section III - 3-phase fault current tables** showing available currents for different wire sizes at varying distances from various transformers appear on pages 19 through 22.

**Section IV - Quick 3-phase short-circuit calculations.** This is one of the simplest methods available and covers systems having a wide variety of circuit components.

**Section V - Classifications of fuse types and applications specifications.**

# SECTION 1: SOURCES OF SHORT-CIRCUIT CURRENTS

## WHERE DO SHORT-CIRCUIT CURRENTS COME FROM?

It is a common misconception to look at the spot where sparks fly and assume that this is the only part of the electrical system involved in a short-circuit fault. However, the fault current does not originate at the fault but is poured into the fault from other sources. All conductors between the source and fault location carry the fault current.

Possible sources of short-circuit currents include:

1. Utility systems
2. Induction motors
3. Generators
4. Synchronous Motors

These have been listed in their order of importance or likelihood of being present.

Occasionally a user owned generator or synchronous motor will furnish substantial short-circuit current but this equipment is not as common and will be touched upon only lightly in this document.

This guide does not deal with utility systems that supply customers but starts at the service entrance and continues inside the user's building. Furthermore, it discusses only the most common interior system of all, the radial system. Other types of internal distribution systems such as networks, are considered special cases outside the scope of this document.

The following diagram represents an elementary radial system with a low voltage bus supplied by a transformer, and supplying several circuits feeding induction motors and other loads.

### 1. UTILITY SYSTEMS

Most current furnished to customers by utilities is supplied by transformers. It is a common misconception that transformers are a source of short-circuit current. Transformers merely receive and deliver short-circuit currents from generating stations.

Transformers are rated in kilovolt-amperes (KVA). (1 kilovolt-ampere = 1000 volt-amperes 1000 VA) The short-circuit output of a transformer in KVA is the same as the short-circuit input in KVA less some small losses.

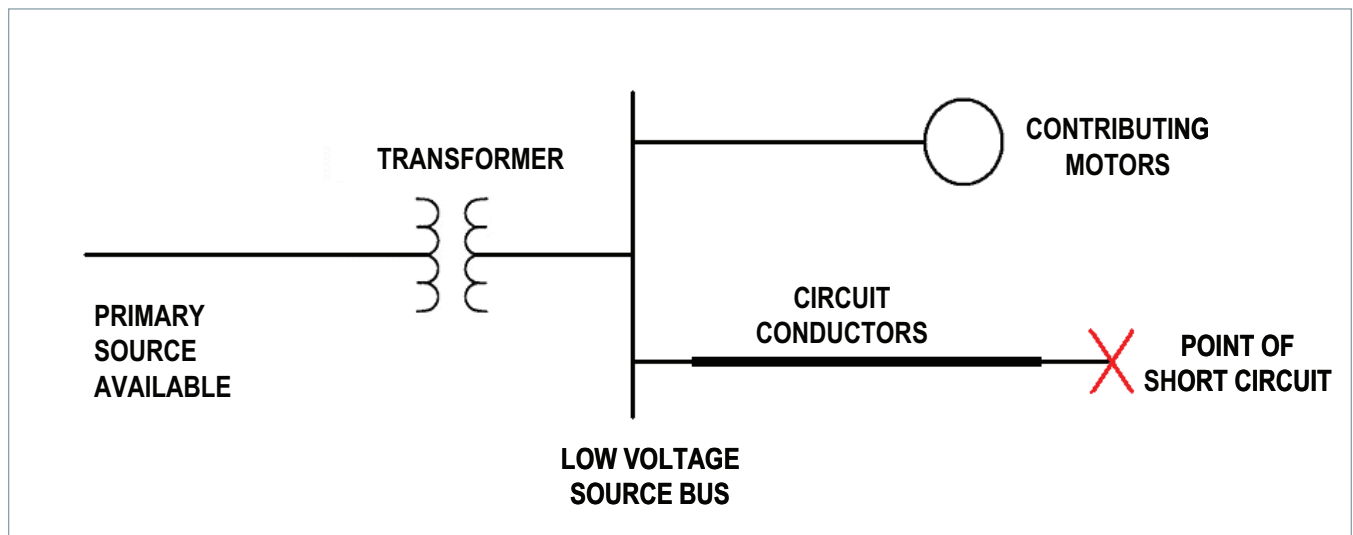

FIG 1 - 1

## SECTION 1: SOURCES OF SHORT-CIRCUIT CURRENTS

The amount of short-circuit current delivered by a transformer is dependent upon the following factors:

- A. Primary source (available KVA)
- B. Secondary voltage
- C. Size or rating of transformer
- D. Impedance of the transformer

### A. Primary Source

In view of the fact that utilities can furnish data on the available KVA at the primary terminals of their transformers it will be unnecessary to concern ourselves with the determination of available primary KVA.

The largest possible primary source is called an 'infinite bus'.

A 500 MVA primary source is generally considered the largest which will be encountered in any practical system. (1 MVA = 1000 KVA = 1,000,000 VA). Any source greater than 500 MVA is considered 'unlimited.'

Any method for determining secondary short-circuit currents of transformers should include a range of available primary MVA.

The Quick 3-phase Short-Circuit Calculations (section IV beginning on page 22) is based on a 500 MVA source. Adjustments can be made to the calculations by applying transformer correction factors (Table A1, page 23) based on primary MVA. Factors are given for the following MVA values: 15, 25, 50, 100, 150 and 250.

If time is not taken to determine and factor in the available primary MVA, calculated short-circuit currents can vary considerably from the actual values.

### B. Secondary voltage

The most common secondary voltages which may be encountered are:

- 120/240 volt single-phase
- 120/208 volt three-phase
- 240 volt three-phase
- 480 volt three-phase (Delta and 277/480 Wye)
- 575 volt three-phase
- 600 volt three-phase

For any given primary source the available secondary short-circuit currents will be different for each secondary voltage and a good set of short-circuit current tables should include sections for each of the above voltages.

### C. Size or rating of Transformers

As previously mentioned, transformers are rated in KVA. They may be either single-phase or three-phase. Three single-phase transformers can be connected for three-phase service. For example:- three 333 KVA single-phase transformers make a 1000 KVA three-phase bank. Some of the more common large transformer ratings are 75, 100, 112.5, 150, 225, 300, 500, 750, 1000, 1500, 2000, and 2500.

In view of the importance attached to 10,000 ampere interrupting ratings by the Code, the inspector should be able to recognize transformers which can deliver more than 10,000 amperes of short-circuit current.

# SECTION 1: SOURCES OF SHORT-CIRCUIT CURRENTS

The information below is a guide for determining the maximum size transformers which can be used without exceeding 10,000 symmetrical R.M.S. amperes at the transformer terminals under short-circuit conditions.

- **120/240 volt single-phase system**  
With the fault occurring on a half-winding, ie. at 120 volts.  
50 kVA at 3% Z or higher  
at up to 25,000 primary kVA  
No motor load
- **120/208 volt three-phase system**  
150 kVA at 3.3% Z or higher  
at up to 500,000 primary kVA  
No motor load
- **240 volt three-phase system**  
112.5 kVA at 4.19% Z or higher  
at up to 500,000 primary kVA  
100% motor load (1,800 amperes contribution)
- **480 volt three-phase system**  
225 kVA at at 4.17% Z or higher  
at up to 500,000 primary kVA  
100% motor load (1,800 amperes contribution)
- **600 volt three-phase system**  
500 kVA at at 4.12% Z or higher  
at up to 150,000 primary kVA  
No motor load

## D. Impedance of Transformers

The word impedance cannot be ignored in determining the available short-circuit current delivered by a transformer, but its meaning can be understood without being technical. It should suffice to say that the impedance of a transformer is the opposition which the transformer exerts to the passage of short-circuit current, or put another way, it is the opposition which the short-circuit current encounters in passing through the transformer.

All transformers have impedance and its magnitude or value is usually expressed in percentage.

The IEEE Definition of IMPEDANCE VOLTAGE OF A TRANSFORMER is: *“The voltage required to circulate rated current through one of two specified windings of a transformer when the other winding is short-circuited, with the windings connected as for rated voltage operation.”* (Note: It is usually expressed in per unit, or percent of the rated voltage of the winding in which the voltage is measured.)

Percentage impedance can be more readily understood from the following explanation:

Percentage impedance is the percentage of the normal rated primary voltage which must be applied to the transformer to cause full rated load current to flow in the short-circuited secondary.

Impedances vary with types and design of transformers. The only way to be absolutely certain is to check the name plate on each transformer.

The impedance for three-phase transformers having ratings of 500 KVA and less varies from 1.6% to 4.5%. Larger transformers are approximately 5.5% impedance. For transformers of the same rating, the one with the lowest impedance will deliver the highest short-circuit current.

Let's illustrate the meaning of % impedance by an example:

A transformer with a 1000 volt primary and a 250 volt secondary has 5% impedance. This can be explained two different ways:

1. 50 volts (5% of 1000 volts) on the primary will produce rated current in the secondary, at zero voltage, with the secondary terminals bolted together.
2. If 5% or 1/20th of the primary voltage will produce full rated current in the bolted secondary, then full primary voltage will produce 20 times full rated current in a bolted or short-circuited secondary.

# SECTION 1: SOURCES OF SHORT-CIRCUIT CURRENTS

The topic of transformer impedance is of importance since it is a determining factor in the amount of short-circuit current that can flow in an electrical system. It can be seen from the example, that when the % impedance of a transformer is reduced, that amount of short-circuit current is significantly increased (i.e.: 5% to 2.5%, doubles the amount of short-circuit current).

It is common place today, as a result of energy and cost savings criteria, to reduce transformer % impedance for use in new applications as well as in the replacement of existing transformers. The resulting increase in short-circuit current could present a serious problem in respect to the interrupting rating of overcurrent devices used and should be carefully analyzed.

(Note: Use of UL Class L, J, R, or CC fuses with 200,000A Interrupting Ratings provides for changes in transformer impedances as well as increases in transformer capacity.)

## 2. INDUCTION MOTORS

During the first few cycles of a fault, induction motors contribute short-circuit current which cannot be ignored in any short-circuit study. Under fault conditions induction motors are driven by the inertia of the loads they have been driving. Momentarily motors act like generators. The output is of very short duration and lasts for only a cycle or two. This contribution is also called feedback.

The short-circuit current delivered by induction motors varies widely from motor to motor. It is seldom possible to determine the motor contribution precisely. First because the number of motors, their size and characteristics are unknown. Secondly, because motors are frequently changed or added in any large building.

An approximate value for the instantaneous short-circuit current from a motor at an instant 1/2 cycle after the short circuit occurs is 3.6 times the full load current. It doesn't vary appreciably whether the motor is lightly loaded or fully loaded when the fault occurs.

On system studies motors are usually grouped and individual characteristics ignored. A frequent assumption is that 50% of the total connected load of a system is induction motors particularly on 120/208Y volt systems having a considerable lighting load. An example would be an office or public building with air-conditioning. (The same building without air-conditioning might have 0 motor load.) Another assumption for voltages of 240V or higher is that 100% of the connected load is induction motors. A factory would be an example of such a load. For 50% motor load the contribution is considered to be 2.5 times the normal load rating of the transformer and for 100% motor load 5 times.

## 3. GENERATORS

As mentioned above, generators on secondary distribution systems are rare. However, we should mention them in passing. Obviously, their contribution of short-circuit current depends upon the size of the generator.

For all practical purposes we can assume that the current delivered by a large generator remains substantially constant during the first few cycles of a short circuit.

## 4. SYNCHRONOUS MOTORS

Synchronous motors act very much like generators except that the short-circuit current does not persist for as long a time, i.e. it decays more quickly. At an instant 1/2 cycle after the short circuit happens the short-circuit current contributed is 4.8 times the full load current.

## SECTION II: SHORT CIRCUIT TERMINOLOGY

Section I is about as free from technical language as it can possibly be. However, it is impossible to discuss short-circuit currents without some understanding of what happens during a short circuit and the terminology.

Section II explains the following terms:

Direct Current . . . . .	Page 9	Random Closing . . . . .	Page 12
Alternating Current . . . . .	Page 9	Available Short-Circuit Current . . . . .	Page 13
Sine Wave . . . . .	Page 9	First Half Cycle Current . . . . .	Page 13
Sinusoidal Wave . . . . .	Page 9	Current Limitation . . . . .	Page 13
Instantaneous Current . . . . .	Page 10	Melting Time . . . . .	Page 13
Peak Current . . . . .	Page 10	Arcing Time . . . . .	Page 13
Average Current . . . . .	Page 10	Total Clearing Time . . . . .	Page 13
Effective Current . . . . .	Page 10	Let-Thru Current . . . . .	Page 13
RMS Current . . . . .	Page 10-11	Triangular Wave . . . . .	Page 14
Symmetrical Current . . . . .	Page 11	Three-Phase Short Circuit . . . . .	Page 14
Asymmetrical Current . . . . .	Page 11	X/R Ratio . . . . .	Page 14
Offset Wave . . . . .	Page 11	Impedance . . . . .	Page 14
Displaced Wave . . . . .	Page 11	Phase Angle . . . . .	Page 14
DC Component . . . . .	Page 11	Power Factor . . . . .	Page 14
Total Current . . . . .	Page 12	I, I <sup>2</sup> and I <sup>2</sup> t . . . . .	Page 16
Decay . . . . .	Page 12	Short-Circuit Current Rating . . . . .	Page 17
Decrement . . . . .	Page 12	Interrupting Rating . . . . .	Page 17
Closing Angle . . . . .	Page 12	Available Fault Current . . . . .	Page 17



## SECTION II: SHORT CIRCUIT TERMINOLOGY

### DIRECT CURRENT

The introduction of direct current in an alternating current analysis is done to provide a relative comparison, to make the understanding of alternating current easier.

The following diagram represents steady current of 10 amperes direct current. As can be seen, the DC value is constant and theoretically unaffected by time.

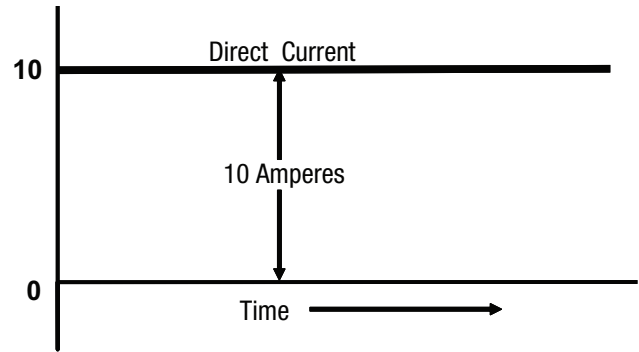

FIG. II-1

### ALTERNATING CURRENT

Alternating currents vary or alternate continuously. They keep changing direction and vary in value from 0 to Maximum back to 0 in one direction and then repeating in the opposite direction.

60 cycle AC currents change direction 60 times per second and one cycle =  $1/60$  second = 0.0167 second.

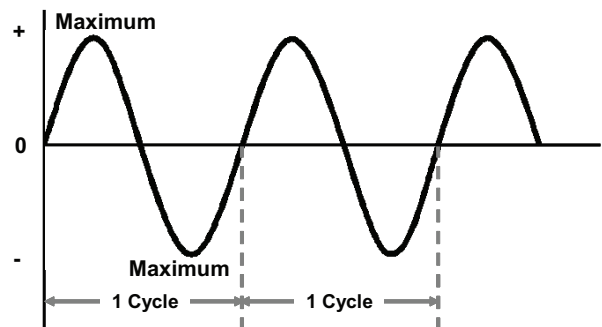

FIG. II-2

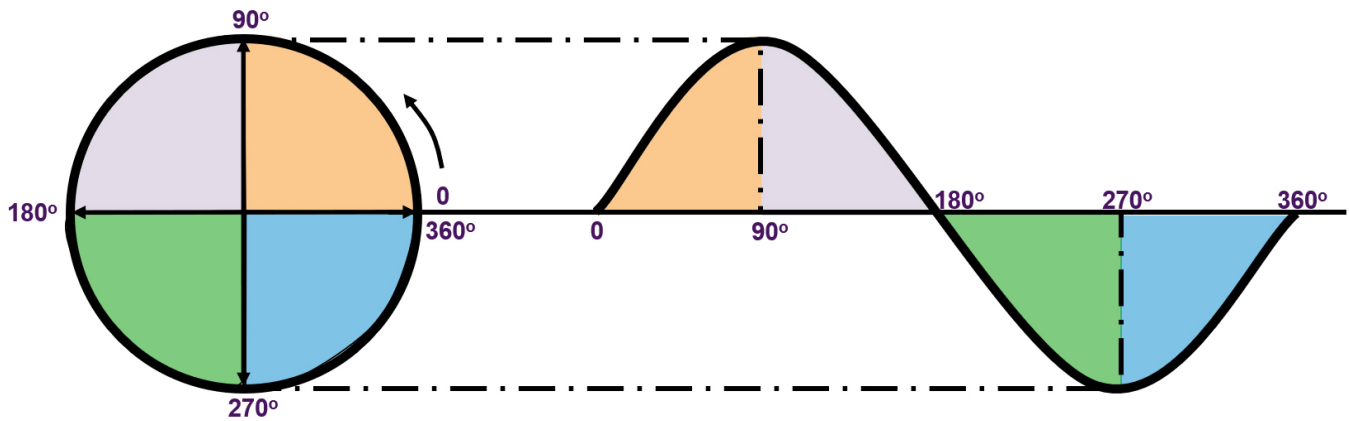

FIG. II-3

### SINE WAVE

All the alternating current circuits which we will consider have currents and voltages following a sine wave. A sine wave is generated by a revolving vector, i.e. inside a rotating machine.

### SINUSOIDAL WAVE

Same as Sine Wave.

## SECTION II: SHORT CIRCUIT TERMINOLOGY

### EFFECTIVE CURRENT

Since an alternating current varies continuously from 0 to maximum to 0 first in one direction and then in the other, it is not readily apparent what the true current value really is.

The current at any point on a sine wave is called the **INSTANTANEOUS CURRENT**. The current at the top of the wave is called the **PEAK OR CREST CURRENT**. It is also possible to determine the ARITHMETIC AVERAGE VALUE of the alternating current, but none of these values correctly relate alternating current to direct current. It is certainly desirable to have 1 ampere of alternating current do the same work as 1 ampere of direct current. This current is called the **EFFECTIVE CURRENT** and 1 ampere of effective alternating current will do the same heating as 1 ampere of direct current.

### RMS CURRENT

Effective current is more commonly called RMS current. RMS means root mean square and is the square root of the average of all the instantaneous currents squared.

The RMS value of a sine wave is readily determined by calculus but can be more easily understood by using simple arithmetic. The example below shows a half sine wave with a 10 ampere maximum or peak value. The complete wave would be 20 amperes from positive crest to negative crest. (Fig. II-4)

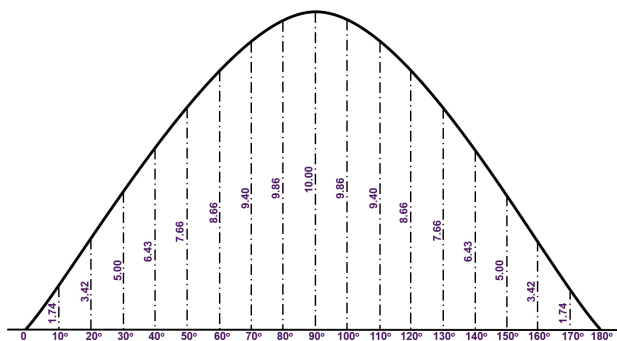

FIG. II-4

For this example, instantaneous currents at 10-degree intervals will be used. The value of the instantaneous currents can be easily measured and have been tabulated in the following table. The squares of these values have also been tabulated. The average instantaneous current and the average squared instantaneous current are found by dividing the totals by 18. The square root of the average squared instantaneous current is shown below the table.

### Calculation of Average and RMS Currents

Degrees	Instantaneous Amperes	Instantaneous Amperes Squared
0	0	0
10	1.74	3.03
20	3.42	11.79
30	5	25
40	6.43	41.35
50	7.66	58.67
60	8.66	75
70	9.4	88.36
80	9.86	97.22
90	10	100
100	9.86	97.22
110	9.4	88.36
120	8.66	75
130	7.66	58.67
140	6.43	41.35
150	5	25
160	3.42	11.79
170	1.74	3.03
180	0	0
<b>Total</b>	<b>114.34</b>	<b>900.9</b>
<b>Average</b>	<b>6.36</b>	<b>50</b>

$$\text{RMS} = \sqrt{50} = 7.07 \text{ amperes}$$

The average current of a sine wave is 0.636 of the peak current and the effective RMS current is 0.707 of the peak current.

## SECTION II: SHORT CIRCUIT TERMINOLOGY

Another way to relate this is that the peak is 1.4 times the RMS value. Standard AC ammeters are marked in RMS amperes and unless stated otherwise all AC currents are considered RMS currents.

For currents which flow for a few cycles or less it is necessary to specify whether the current is RMS (effective), Peak (crest), Average, or Instantaneous.

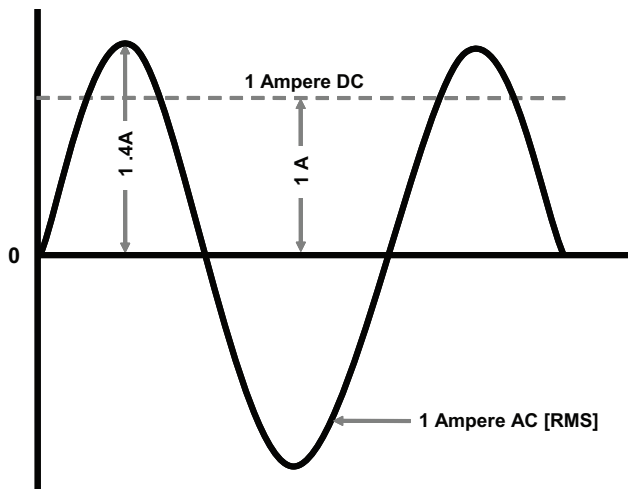

FIG. II-5

The two currents shown above have the same effective value.

### SYMMETRICAL CURRENT

A symmetrical current wave is symmetrical about the zero axis of the wave. This wave has the same magnitude above & below the zero axis.

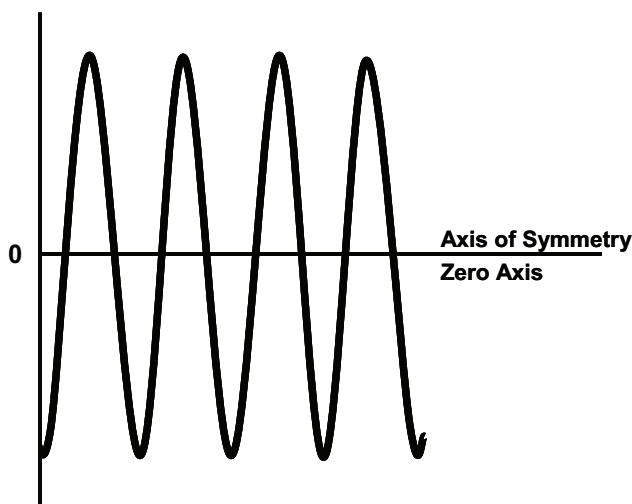

FIG. II-6

### ASYMMETRICAL CURRENT

An asymmetrical current wave is not symmetrical about the zero axis. The axis of symmetry is displaced or offset from the zero axis, and the magnitude above and below the zero axis are not equal.

### OFFSET CURRENT

An asymmetrical wave can be partially offset or fully offset. Fig. II-7 shows a fully offset wave. Offset waves are sometimes called **DISPLACED WAVES**.

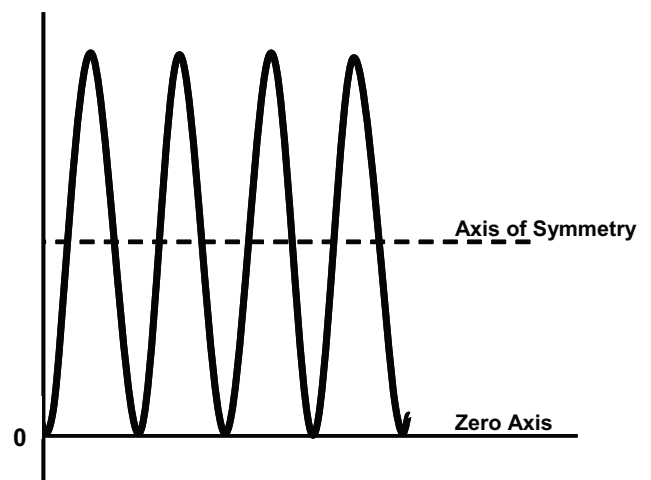

FIG. II-7

### D.C. COMPONENT

The axis of symmetry of an offset wave resembles a DC current and asymmetrical currents can be readily handled if considered to have an AC component and a DC component. These components are theoretical. The DC component is generated within the AC system and has no external source.

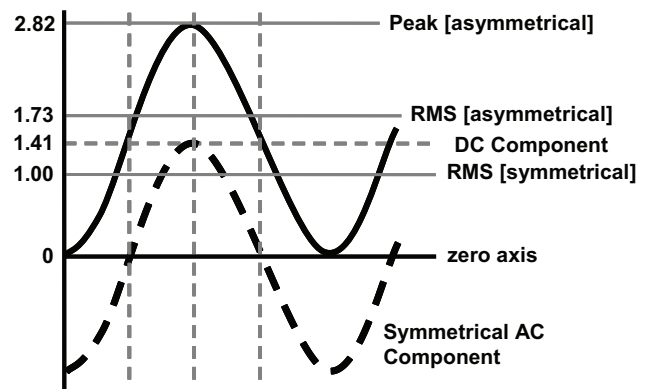

FIG. II-8

## SECTION II: SHORT CIRCUIT TERMINOLOGY

Fig. II-8 shows a fully offset asymmetrical current with a steady DC component as its axis of symmetry. The symmetrical component has the zero axis as its axis of symmetry. If the RMS or effective value of the symmetrical current is 1, then the peak of the symmetrical current is 1.41. This is also the effective value of the DC component. We can add these two effective currents together by the square root of the sum of the squares and get the effective or RMS value of the asymmetrical current.

$$I_{asy} = \sqrt{(I_{DC}^2 + I_{sym}^2)}$$
$$I_{asy} = \sqrt{((1.41)^2 + (1)^2)} = \sqrt{3} = 1.73$$

The RMS value of a fully offset asymmetrical current is 1.73 times the symmetrical RMS current. The peak asymmetrical current is twice the peak symmetrical current, i.e.  $2 \times 1.41 = 2.82$ .

### TOTAL CURRENT

The term total current is used to express the total or sum of the AC component and the DC component of an asymmetrical current.

Total current and TOTAL ASYMMETRICAL CURRENT have the same meaning and may be expressed in peak or RMS amperes.

### DECAY

Unfortunately fault currents are neither symmetrical nor fully asymmetrical but somewhere in between. The DC component is usually short lived and decays over time.

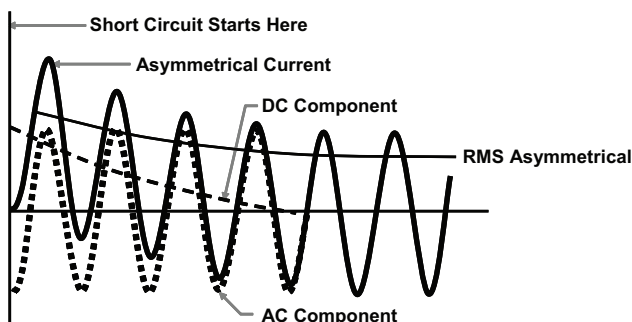

FIG II-9

In the above diagram the DC component decays to zero in about four cycles. The rate of decay is

called **DECAYMENT** and depends upon the circuit constants. The DC component would never decay in a circuit having reactance but zero resistance and would remain constant forever. In a circuit having resistance but zero reactance the DC component would decay instantly. These are theoretical conditions and all circuits have some resistance and reactance, and the DC component disappears in a few cycles.

### CLOSING ANGLE

A short-circuit fault can occur at any point on the voltage wave of a circuit. So far, this discussion has avoided voltage characteristics, but the voltage wave resembles the current wave. The two waves may be in phase or out of phase and the magnitude and symmetry of the current wave on a short circuit depends on the point on the voltage wave at which the short occurs.

In laboratory tests it is possible to pick the point on the voltage wave where the fault occurs by closing the circuit at any desired angle on the voltage wave. The closing angle can be chosen to produce the desired current conditions. This is called Controlled Closing.

### RANDOM CLOSING

In real life faults can occur anywhere on the voltage wave and in a laboratory, this can be duplicated by closing the circuit at random. This is known as random closing. The following is true of a short circuit having negligible resistance:

- 1) If the fault occurs at zero voltage the current wave is fully asymmetrical, thus a maximum value of short circuit current is obtained.
- 2) If the fault occurs at maximum voltage the current wave is completely symmetrical, and a minimum value of short circuit current is obtained.
- 3) Most natural faults occur somewhere between these two extremes.



## SECTION II: SHORT CIRCUIT TERMINOLOGY

### AVAILABLE SHORT-CIRCUIT CURRENT

Figure II-9 shows a waveform that is neither symmetrical or asymmetrical. At first glance, the value of available short circuit current may not be clear. Referring again to Fig II-9, it can be said that it is symmetrical after about 4 cycles, and we can properly talk about the available short-circuit current in RMS symmetrical amperes after the DC component becomes zero. The total RMS asymmetrical current at 1, 2, 3 cycles or any other time after the short circuit started can also be determined.

### FIRST HALF CYCLE CURRENT

The accepted practice is to use the current which is available 1/2 cycle after the short circuit starts. For a fully offset wave the maximum current occurs at the end of the first half cycle of time. Because this is the worst case, the peak and RMS currents should be determined at this point. Since the DC component has already started to decay, the values shown in Fig. II-8 where there is no decay cannot be used.

As already mentioned, the rate of decay depends upon the circuit constants. A study of actual circuits of 600 volts or less indicates that the proper 1/2 cycle value for the RMS asymmetrical current is 1.4 times the RMS symmetrical current, and the peak instantaneous current is 1.7 times the RMS asymmetrical current.

$$1.7 \times 1.4 = 2.4 \text{ RMS symmetrical current}$$

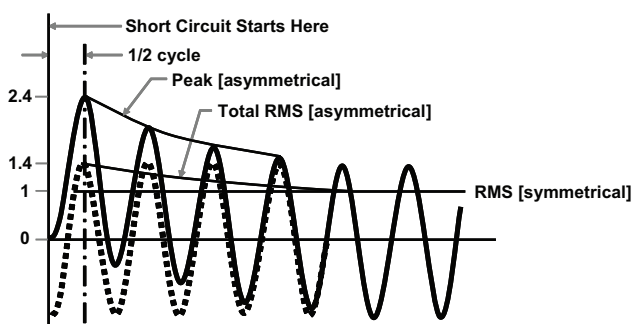

FIG II-10

### CURRENT LIMITATION

The significant reduction of available short-circuit current, in a circuit, by use of a device that prevents this short-circuit current from reaching its maximum value, is called Current Limitation. Fuses which perform this function are known as Current Limiting. Current Limiting fuses operate in less than 1/2 cycle, thus interrupting the short-circuit current before it can achieve its maximum value. The resultant reduction (refer to shaded segment of Fig. II - 11) is substantially less than the maximum value of available short-circuit current.

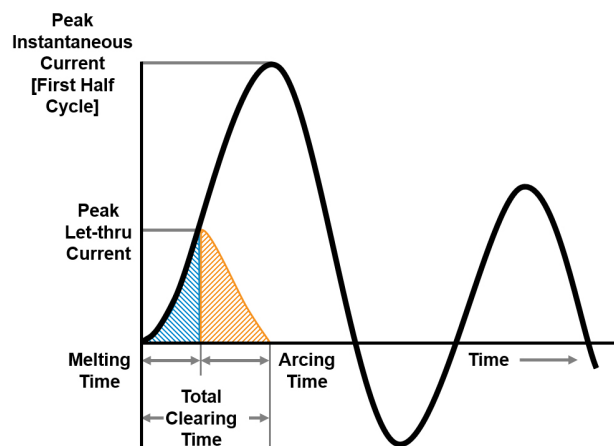

FIG. II-11

This figure shows the current-limiting action of these fuses. The **MELTING TIME** is the time required to melt the fusible link. The **ARCING TIME** is the time required for the arc to burn back the fusible link and reduce the current to zero. **TOTAL CLEARING TIME** is the sum of the melting and arcing times and is the time from fault initiation to extinction.

### LET-THRU CURRENT

The maximum instantaneous or peak current which passes through the fuse is called the let-thru current. This value can be expressed in RMS amperes also. The value of let-thru current is used in the determination of electrical equipment protection, as required by the NEC, Article 110.10.

## SECTION II: SHORT CIRCUIT TERMINOLOGY

### TRIANGULAR WAVE

The rise and fall of the current through a current-limiting fuse resembles an isosceles triangle, and can be assumed to be a triangle without introducing an appreciable error. Since this is not a sine wave, we cannot determine the RMS value of the let-thru current by taking .707 of the peak value as for a sine wave. In this case the effective or RMS value of a triangular wave is equal to the peak value divided by  $\sqrt{3}$ .

$$I_{rms} = \frac{I_{peak}}{\sqrt{3}} = \frac{I_{peak}}{1.73}$$

The let-thru current of a current-limiting fuse varies with the design, ampere rating and available short-circuit current. Fuse manufacturers furnish let-thru curves for their various types of current-limiting fuses.

### THREE-PHASE SHORT CIRCUITS

Three-phase short-circuit currents can be determined using the same method as single-phase currents if we assume one phase is symmetrical. The three phases each have different current values at any instant. Only one can be fully asymmetrical at a given time. This is called the **MAXIMUM OR WORST PHASE** and its RMS current value can be found by multiplying the symmetrical RMS current by the proper factor. The currents in the three phases can be averaged and the **AVERAGE 3-PHASE RMS AMPERES** can be determined by multiplying the symmetrical RMS current by the proper factor. The common factor is 1.25 times the RMS symmetrical current which corresponds with an 8.5% power factor. The table on page 14 includes multiplying factors for various power factors.

### X/R RATIO

Every practical circuit contains resistance (R) and inductive reactance (X). These are electrically in series. Their combined effect is called IMPEDANCE (Z). When current flows thru an inductance (coil) the voltage leads the current by 90° and when current flows thru a resistance the voltage and

current are in phase. This means that X and R must be combined vectorially to obtain impedance.

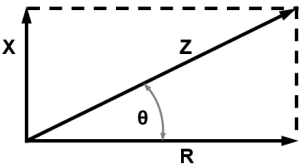

$$Z = \sqrt{R^2 + X^2}$$

$$\frac{X}{R} = \tan \theta$$

### POWER FACTOR

Power factor is defined as the ratio of real power (KW) to apparent power (KVA).

$$PF = \frac{KW \text{ (Real Power)}}{KVA \text{ (Apparent Power)}}$$

KW are measured with a wattmeter. KVA are determined with a voltmeter and an ammeter and the voltage and current waves may be in a phase or out of phase. KW and KVA can be combined by a right-angle relationship as shown:

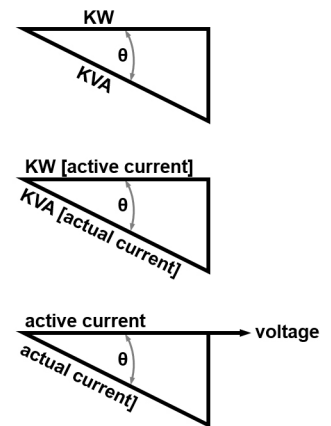

The active current is in phase with the voltage. The actual current or line current, as read on an ammeter, lags the voltage by an amount equal to the phase angle.

$$\text{Power Factor} = \cos \theta$$

$$X/R = \tan \theta$$

The power factor is said to be 1 or unity or 100% when the current and voltage are in phase i.e. when

$\theta = 0$  degrees. ( $\cos 0 = 1$ ). The power factor is 0 when  $\theta$  is 90 degrees. ( $\cos 90 = 0$ ).

The X/R ratio determines the power factor of a circuit and on the following pages gives power factor for various X/R ratios.

## SECTION II: SHORT CIRCUIT TERMINOLOGY

SHORT CIRCUIT POWER FACTOR PERCENT	SHORT CIRCUIT X/R RATIO	MULTIPLYING FACTOR		
		MAXIMUM 1-PHASE RMS AMPERES AT 1/2 CYCLE	AVERAGE 3-PHASE RMS AMPERES AT 1/2 CYCLE	MAXIMUM PEAK AMPERES AT 1/2 CYCLE
0	0	1.732	1.394	2.828
1	100	1.696	1.374	2.785
2	49.993	1.655	1.355	2.743
3	33.322	1.63	1.336	2.702
4	24.979	1.598	1.318	2.663
5	19.974	1.568	1.301	2.625
6	16.623	1.54	1.285	2.589
7	14.251	1.511	1.27	2.554
8	12.46	1.485	1.256	2.52
8.5	11.723	1.473	1.248	2.504
9	11.066	1.46	1.241	2.487
10	9.95	1.436	1.229	2.455
11	9.035	1.413	1.216	2.424
12	8.273	1.391	1.204	2.394
13	7.627	1.372	1.193	2.364
14	7.072	1.35	1.182	2.336
15	6.591	1.33	1.171	2.309
16	6.17	1.312	1.161	2.282
17	5.797	1.294	1.152	2.256
18	5.465	1.277	1.143	2.231
19	5.167	1.262	1.135	2.207
20	4.899	1.247	1.127	2.183
21	4.656	1.232	1.119	2.16
22	4.434	1.218	1.112	2.138
23	4.231	1.205	1.105	2.11
24	4.045	1.192	1.099	2.095
25	3.873	1.181	1.093	2.074
26	3.714	1.17	1.087	2.054
27	3.566	1.159	1.081	2.034
28	3.429	1.149	1.075	2.015
29	3.3	1.139	1.07	1.996
30	3.18	1.13	1.066	1.978
31	3.067	1.121	1.062	1.96
32	2.961	1.113	1.057	1.943
33	2.861	1.105	1.053	1.926
34	2.766	1.098	1.049	1.91
35	2.676	1.091	1.046	1.894
36	2.592	1.084	1.043	1.878
37	2.511	1.078	1.039	1.863
38	2.434	1.073	1.036	1.848
39	2.361	1.068	1.033	1.833
40	2.291	1.062	1.031	1.819

## SECTION II: SHORT CIRCUIT TERMINOLOGY

SHORT CIRCUIT POWER FACTOR PERCENT	SHORT CIRCUIT X/R RATIO	MULTIPLYING FACTOR		
		MAXIMUM 1-PHASE RMS AMPERES AT 1/2 CYCLE	AVERAGE 3-PHASE RMS AMPERES AT 1/2 CYCLE	MAXIMUM PEAK AMPERES AT 1/2 CYCLE
41	2.225	1.057	1.028	1.805
42	2.161	1.053	1.026	1.791
43	2.1	1.049	1.024	1.778
44	2.041	1.045	1.022	1.765
45	1.985	1.041	1.02	1.753
46	1.93	1.038	1.019	1.74
47	1.878	1.034	1.017	1.728
48	1.828	1.031	1.016	1.716
49	1.779	1.029	1.014	1.705
50	1.732	1.026	1.013	1.694
55	1.519	1.015	1.008	1.641
60	1.333	1.009	1.004	1.594
65	1.169	1.004	1.002	1.553
70	1.02	1.002	1.001	1.517
75	0.882	1.001	1	1.486
80	0.75	1	1	1.46
85	0.62	1	1	1.439
100	0	1	1	1.414

### I, I<sup>2</sup>, AND I<sup>2</sup>t

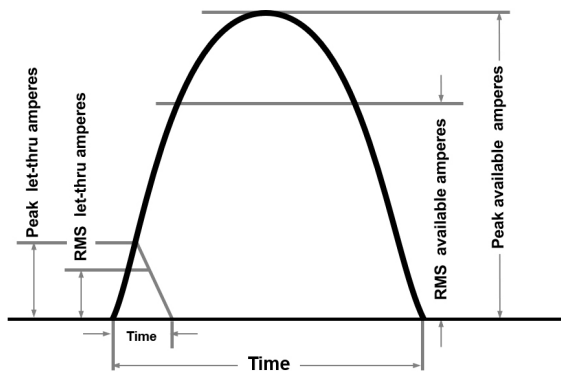

FIG II-14

The small triangle shows current and time variation when a current-limiting fuse interrupts a high fault current. The current starts to rise but the fuse element melts before the available current can get through. The current drops to zero in the duration marked as 'time'. The peak of the triangle shows the peak current which the fuse lets through. This current can also be expressed in RMS amperes. It should be noted that current-limiting fuses limit both current and time.

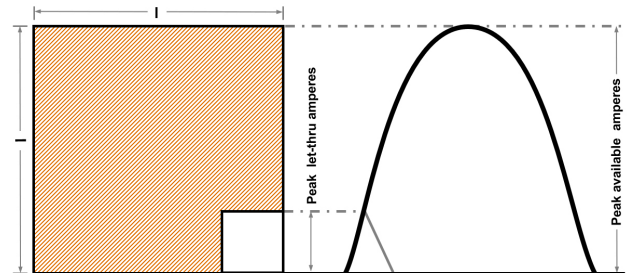

FIG. II-15

$I_p^2$  is a measure of the Mechanical Force caused by peak current ( $I_p$ ). This is the electro-magnetic force which mechanically damages bus structures, cable supports and equipment enclosures.

Squaring the available peak current of the circuit gives a very large number in comparison to the square of the peak let-thru current of the current-limiting fuse. The difference in the size of the two squares indicates the difference between having and not having a current-limiting fuse in a circuit.

$I^2t$  is a measure of the heating effect or Thermal Energy of a fault.  $I^2t$  current uses RMS amperes instead of peak amperes, used for mechanical



## SECTION II: SHORT CIRCUIT TERMINOLOGY

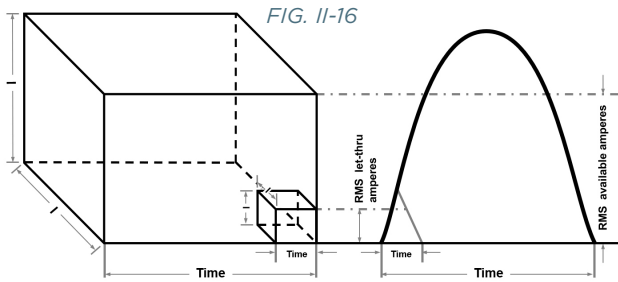

forces. The difference in size of the large cube-like figure and the small cube-like figure represents the difference in heating effect between having and not having a current-limiting fuse in a circuit.  $I^2t$  is a measure of the heating effect which burns off conductors such as pigtailed in breakers and heater coils in motor controllers. It also welds butt contacts in contactors and breakers.  $I^2t$  units are ampere squared seconds.

These values of Mechanical Force ( $I_p^2$ ) and Thermal Energy ( $I^2t$ ) are valuable in determining the protection of electrical equipment. At any point in a distribution system the equipment must be capable of handling the Mechanical Force and Thermal Energy available. Should these values exceed the capabilities of the equipment, either the equipment must be reinforced, or a current limiting fuse used to reduce the amount of force and energy available to the equipment. This is referred to in article 110.10 of the National Electrical Code.

### SHORT-CIRCUIT CURRENT RATING

The maximum specified value of Voltage and Current that equipment can safely “handle” is known as its “SHORT-CIRCUIT CURRENT RATING”, or SCCR. As previously shown short-circuit current translates into Mechanical Force ( $I_p^2$ ) and Thermal Energy ( $I^2t$ ) which can destroy equipment and create hazardous conditions.

Therefore, for equipment protection, the SCCR should never be less than the available short-circuit current at the equipment location. Such conditions cannot always be avoided. Hence, the current-limiting ability of fuses is utilized to reduce the short-circuit current to a value LESS THAN the equipment Short-Circuit Current Rating.

### INTERRUPTING RATING

The maximum specified value of short-circuit current that an overcurrent protective device (fuse or circuit breaker) can safely open or clear is known as its INTERRUPTING RATING. For circuit breakers there are numerous ratings ranging from 10,000 up. (i.e. 10,000, 14,000, 22,000, 42,000, 65,000 etc.). In the case of modern current-limiting fuses (UL class R, J and L) there is one rating, 200,000 ampere RMS. Older fuse types (UL Class H and K) had 10,000, 50,000 and 100,000 ampere ratings.

The Interrupting Ratings of overcurrent protective devices must never be exceeded if serious damage is to be avoided. Hence, the use of One-Time or Renewable, 10,000 ampere Class H fuses can create serious concern. Extreme caution must be exercised so that their 10,000-ampere rating is not exceeded. Further, NEC only permits installing these fuses for “replacement in existing installations where there is no evidence of overfusing or tampering.” This problem is eliminated with the application of 200,000 ampere rated fuses.

It is worthwhile to note that switches which have a rating greater than 10,000 Amps. (i.e.; 100,000 or 200,000 Amps) must utilize UL Class J or Class R 200,000 ampere current-limiting fuses along with their respective fuse clip assemblies.

### AVAILABLE FAULT CURRENT

The value of the available fault current can be determined by using the tables in Section III or by using the quick 3 phase short-circuit calculation method shown in Section IV. The Short Circuit calculation method is more accurate because it considers all components in the system to the actual fault point. Either method allows quick determination of fault levels. Familiarity with these methods is essential to assure the proper choice of equipment and protective devices.

NOTE: For further detailed information regarding overcurrent protection of electrical equipment and compliance with the National Electrical Code, refer to the Application Information section of the Advisor, Mersen’s full-line catalog.

# SECTION III: 3-PHASE FAULT CURRENT TABLES

## USE OF FAULT CURRENT TABLES

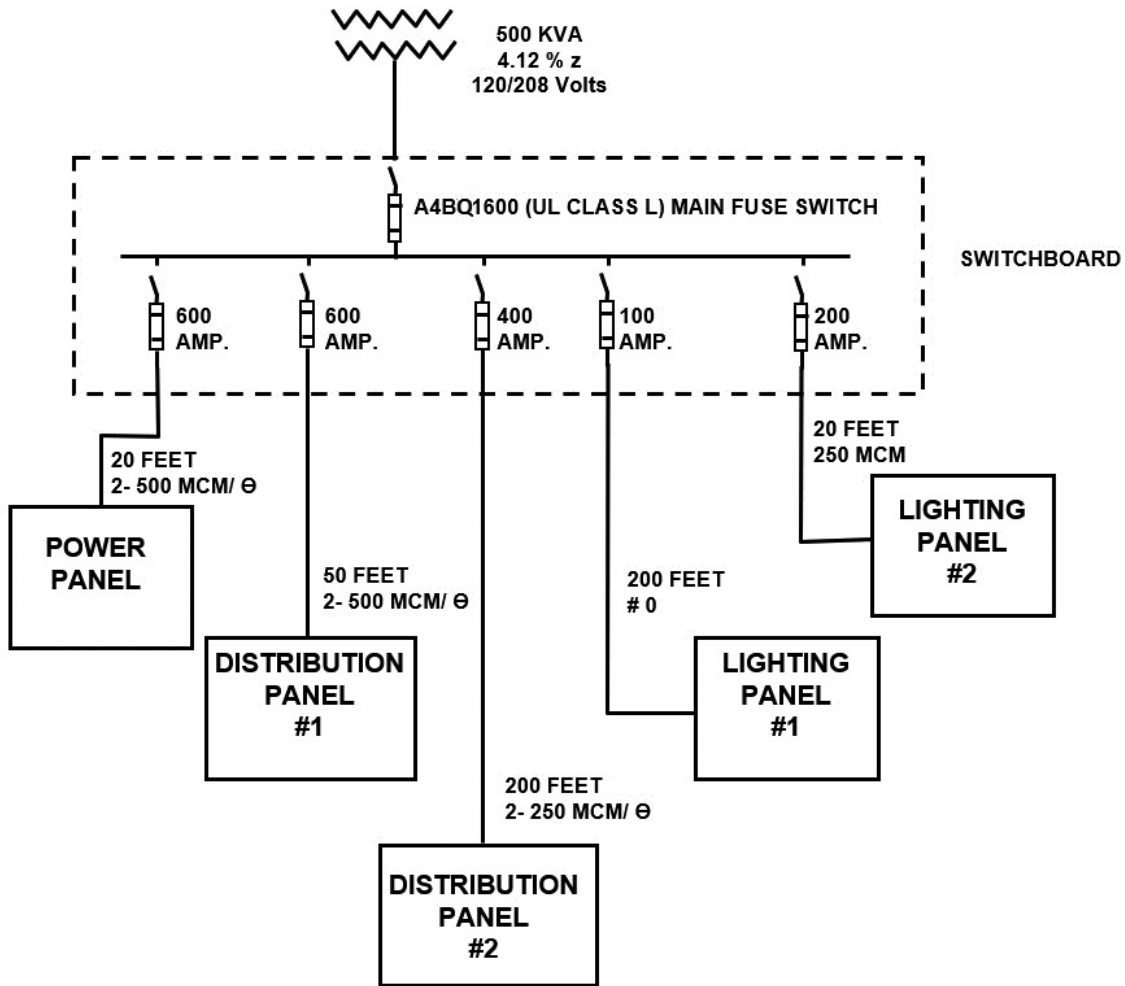

FIG. III-1

A 500 KVA liquid filled transformer with nominal impedance of 4.12% and a secondary voltage of 120/208 volts feeds a small industrial system as indicated in the above one-line diagram. Although two lighting panels are included, they are only a small part of the total load and therefore the 100% motor load on which the tables are based will give conservative results.

From the 208 volts short-circuit current tables on page 19 the following values of fault current (to the right) are obtained by reading down to 500 KVA for the conductor size used and reading across to distance from the switchboard.

Location	Symmetrical [rms amperes]
Switchboard	38,200
Power Panel	34,600
Distribution Panel #1	29,400
Distribution Panel #2	3,200
Lighting Panel #1	29,400
Lighting Panel #2	4,000

# SECTION III: 3-PHASE FAULT CURRENT TABLES

Table 1: 3 ø Fault Current Available [symmetrical rms amperes] 208 Volts										
KVA Rating of Transformer	Copper Conductor Size Per Phase	Distance from Transformer to Point of Fault - Feet								
		0	5	10	20	50	100	200	500	1,000
150 (4.19% Z)	# 4	11,500	10,700	10,000	8,500	5,400	3,200	1,750	720	350
	# 0	11,500	11,120	10,750	10,050	8,070	5,850	3,600	1,620	860
	250 MCM	11,500	11,300	11,050	10,550	9,250	7,600	5,550	3,000	1,600
	2 - 250 MCM	11,500	11,400	11,250	11,050	10,300	9,240	7,600	4,820	3,000
255 (4.17% Z)	# 4	17,220	15,700	13,950	12,000	6,100	3,400	1,800	750	400
	# 0	17,220	16,450	15,600	14,100	10,400	6,750	3,600	1,700	900
	250 MCM	17,220	16,700	16,200	15,200	12,600	9,750	6,500	3,200	1,700
	2 - 250 MCM	17,220	17,000	16,700	16,200	14,700	12,700	9,600	5,600	3,250
	2 - 500 MCM	17,220	17,100	16,900	16,500	15,300	13,700	11,300	7,200	4,500
300 (4.16% Z)	# 4	23,000	20,400	17,100	12,600	6,500	3,500	1,800	750	400
	# 0	23,000	21,600	20,200	17,500	13,950	7,500	4,000	1,750	900
	250 MCM	23,000	22,100	21,200	19,500	15,300	2,200	7,300	3,350	1,750
	2 - 250 MCM	23,000	22,500	22,000	21,200	18,500	15,300	11,300	6,000	3,300
	2 - 500 MCM	23,000	22,750	22,450	21,700	19,550	16,800	13,300	7,900	4,550
500 (4.12% Z)	# 4	38,200	30,800	24,000	15,400	6,900	3,500	1,800	800	400
	# 0	38,200	34,400	30,400	24,000	14,200	8,000	4,000	1,800	1,000
	250 MCM	38,200	36,000	33,800	29,400	20,100	13,600	8,000	3,400	1,800
	2 - 250 MCM	38,200	36,900	35,700	33,300	27,000	20,100	13,200	6,400	3,500
	2 - 500 MCM	38,200	37,400	36,500	34,600	29,400	23,800	17,000	9,000	5,000
750 (5.19% Z)	# 4	47,200	35,800	26,000	16,000	6,900	3,400	1,900	800	400
	# 0	47,200	41,900	36,300	27,300	14,800	8,000	4,100	1,800	950
	250 MCM	47,200	43,600	40,000	34,300	23,000	14,000	8,000	3,200	1,700
	2 - 250 MCM	47,200	45,100	43,300	40,000	31,700	22,800	14,400	6,900	3,500
	2 - 500 MCM	47,200	45,900	44,300	41,700	34,600	27,000	18,300	9,200	5,000
1000 (5.19% Z)	# 4	62,700	43,000	29,100	17,000	7,800	3,700	1,800	700	400
	# 0	62,700	53,500	44,300	31,200	16,000	8,500	4,400	1,800	950
	250 MCM	62,700	56,600	51,000	42,000	26,000	15,900	8,800	3,400	1,870
	2 - 250 MCM	62,700	59,900	56,300	50,400	37,800	25,900	1,500	6,900	3,500
	2 - 500 MCM	62,700	61,800	58,200	54,700	42,400	31,500	21,000	10,000	5,300
1500 (5.18% Z)	# 4	92,400	53,000	33,000	18,100	7,800	3,900	2,000	800	600
	# 0	92,400	73,500	57,000	36,500	17,800	9,200	4,600	2,000	1,000
	250 MCM	92,400	80,000	69,500	52,000	30,000	17,400	9,200	3,800	2,000
	2 - 250 MCM	92,400	85,700	79,500	68,500	46,000	30,000	17,600	7,000	3,800
	2 - 500 MCM	92,400	88,000	83,000	74,000	57,000	38,000	23,800	11,000	6,000
2000 (5.17% Z)	# 4	121,800	58,000	33,800	18,200	7,200	3,800	1,800	600	-
	# 0	121,800	88,000	63,700	38,000	17,000	8,800	4,200	1,800	800
	250 MCM	121,800	100,200	83,800	60,000	31,000	17,000	8,500	3,200	1,800
	2 - 250 MCM	121,800	110,800	100,500	83,000	50,000	30,000	17,000	6,800	3,500
	2 - 500 MCM	121,800	114,200	106,000	91,000	62,000	40,000	23,900	10,000	5,000

## SECTION III: 3-PHASE FAULT CURRENT TABLES

Table 2: 3 ø Fault Current Available (symmetrical rms amperes) 240 Volts										
KVA Rating of Transformer	Copper Conductor Size Per Phase	Distance from Transformer to Point of Fault - Feet								
		0	5	10	20	50	100	200	500	1,000
150 (4.19% Z)	# 4	9,980	9,520	9,000	8,000	5,580	3,440	1,900	800	400
	# 0	9,980	9,700	9,450	9,000	7,600	5,850	3,900	1,800	9,500
	250 MCM	9,980	9,820	9,660	9,350	8,500	7,220	5,550	3,200	1,900
	2 - 250 MCM	9,980	9,900	9,800	9,650	9,200	8,400	7,200	4,900	3,200
255 (4.17% Z)	# 4	14,940	13,800	12,800	10,600	6,500	3,800	2,000	800	450
	# 0	14,940	14,500	14,000	12,900	10,100	7,100	4,300	2,000	1,000
	250 MCM	14,940	14,600	14,300	13,600	11,800	9,500	6,800	3,500	1,800
	2 - 250 MCM	14,940	14,700	14,500	14,300	13,200	11,700	9,400	6,000	3,500
	2 - 500 MCM	14,940	14,800	14,700	14,500	13,600	12,500	10,600	7,500	5,000
300 (4.16% Z)	# 4	19,970	18,000	16,000	12,700	7,000	4,000	2,000	800	400
	# 0	19,970	19,100	18,100	16,200	11,800	7,800	4,500	2,000	1,000
	250 MCM	19,970	19,300	18,700	17,500	14,500	11,200	7,500	3,600	2,000
	2 - 250 MCM	19,970	19,500	19,300	18,700	17,000	14,500	11,200	6,400	3,600
	2 - 500 MCM	19,970	19,600	19,400	19,000	17,600	15,600	13,000	8,200	5,200
500 (4.12% Z)	# 4	33,100	28,000	22,900	15,900	7,800	4,200	2,200	900	500
	# 0	33,100	30,800	28,000	23,100	14,800	9,000	4,900	2,000	1,000
	250 MCM	33,100	31,500	30,000	27,000	20,300	14,200	8,800	4,000	2,000
	2 - 250 MCM	33,100	32,300	31,400	29,800	25,300	20,100	14,000	7,000	3,900
	2 - 500 MCM	33,100	32,600	32,000	30,700	22,200	22,500	17,000	9,600	5,500
750 (5.19% Z)	# 4	40,900	33,000	26,000	17,000	8,000	4,000	2,000	900	500
	# 0	40,900	37,400	33,900	27,000	15,900	9,200	5,000	2,000	1,000
	250 MCM	40,900	38,300	36,000	32,000	23,000	15,000	8,900	3,900	2,050
	2 - 250 MCM	40,900	39,800	38,500	36,000	30,000	22,900	15,000	7,300	4,000
	2 - 500 MCM	40,900	40,100	39,100	37,100	32,000	26,100	19,000	10,100	5,600
1000 (5.19% Z)	# 4	54,400	41,000	29,500	18,000	8,200	4,200	2,100	950	400
	# 0	54,400	48,800	42,200	32,100	17,900	9,900	5,000	2,050	1,000
	250 MCM	54,400	50,100	46,300	39,900	27,000	17,000	9,500	4,000	2,050
	2 - 250 MCM	54,400	52,100	50,000	46,000	36,800	26,900	17,000	8,000	4,050
	2 - 500 MCM	54,400	52,800	51,000	48,000	40,300	31,800	22,000	11,200	6,000
1500 (5.18% Z)	# 4	80,100	53,200	35,500	20,500	9,900	4,800	2,500	1,200	900
	# 0	80,100	66,500	55,000	40,000	20,000	10,500	5,800	2,800	1,800
	250 MCM	80,100	72,000	64,500	52,000	32,000	19,500	10,100	4,500	3,000
	2 - 250 MCM	80,100	76,000	72,000	64,000	47,000	32,000	19,500	8,500	4,800
	2 - 500 MCM	80,100	77,500	74,000	68,000	53,500	40,000	25,500	12,000	6,500
2000 (5.17% Z)	# 4	105,600	60,500	38,000	21,000	8,800	4,300	2,200	800	-
	# 0	105,600	83,000	64,000	42,000	20,000	10,300	5,500	2,500	1,200
	250 MCM	105,600	90,500	79,000	60,000	34,500	19,800	10,200	4,500	2,400
	2 - 250 MCM	105,600	97,500	91,000	78,000	54,000	34,000	19,000	8,500	4,600
	2 - 500 MCM	105,600	100,000	94,500	84,000	62,500	43,500	27,000	12,000	6,200



# SECTION III: 3-PHASE FAULT CURRENT TABLES

Table 3-3 ∅ Fault Current Available [symmetrical rms amperes] 480 Volts										
KVA Rating of Transformer	Copper Conductor Size Per Phase	Distance from Transformer to Point of Fault - Feet								
		0	5	10	20	50	100	200	500	1,000
150 (4.19% Z)	# 4	4,990	4,930	4,880	4,770	4,420	3,800	2,800	1,480	790
	# 0	4,990	4,940	4,920	4,880	4,700	4,400	3,850	2,650	1,680
	250 MCM	4,990	4,960	4,930	4,910	4,800	4,600	4,250	3,350	2,500
	2 - 250 MCM	4,990	4,970	4,940	4,920	4,900	4,800	4,600	4,050	3,350
255 (4.17% Z)	# 4	7,470	7,380	7,240	7,000	6,140	4,880	3,300	4,600	840
	# 0	7,470	7,400	7,320	7,200	6,800	6,200	5,100	3,180	1,860
	250 MCM	7,470	7,420	7,360	7,300	7,040	6,640	5,900	4,400	3,000
	2 - 250 MCM	7,470	7,440	7,400	7,350	7,220	7,000	6,600	5,580	4,300
	2 - 500 MCM	7,470	7,460	7,450	7,400	7,300	7,100	6,800	6,000	5,000
300 (4.16% Z)	# 4	9,985	9,800	9,600	9,100	7,600	5,600	3,560	1,620	840
	# 0	9,985	9,840	9,750	9,520	8,800	7,650	5,900	3,400	1,920
	250 MCM	9,985	9,880	9,800	9,660	9,240	8,500	7,300	5,000	3,240
	2 - 250 MCM	9,985	9,920	9,825	9,790	9,580	9,200	8,450	6,200	5,020
	2 - 500 MCM	9,985	9,950	9,850	9,800	9,660	9,400	8,820	7,500	5,880
500 (4.12% Z)	# 4	16,550	16,000	15,400	14,000	10,250	6,800	3,800	1,600	800
	# 0	16,550	16,200	15,950	15,250	13,250	10,500	7,400	3,500	1,900
	250 MCM	16,550	16,300	16,050	15,700	14,500	12,700	10,000	5,900	3,500
	2 - 250 MCM	16,550	16,350	16,250	16,100	15,450	14,400	12,500	9,000	6,000
	2 - 500 MCM	16,550	16,400	16,350	16,300	15,700	14,800	13,400	10,500	7,500
750 (5.19% Z)	# 4	20,450	19,700	18,700	16,800	11,700	7,500	4,000	1,600	800
	# 0	20,450	20,000	19,500	18,700	16,000	12,400	8,100	3,800	2,000
	250 MCM	20,450	20,200	19,800	19,250	17,500	15,500	11,500	6,600	3,800
	2 - 250 MCM	20,450	20,250	20,200	19,700	19,000	17,500	15,000	10,500	6,600
	2 - 500 MCM	20,450	20,400	20,250	19,900	19,300	18,200	16,300	12,000	8,400
1000 (5.19% Z)	# 4	27,200	26,000	24,200	21,000	13,400	7,900	4,400	1,800	800
	# 0	27,200	26,700	25,900	24,300	20,000	14,400	9,000	4,100	200
	250 MCM	27,200	26,900	26,400	25,300	22,400	18,600	13,600	7,200	4,000
	2 - 250 MCM	27,200	27,000	26,700	26,200	24,500	22,200	18,500	12,100	7,200
	2 - 500 MCM	27,200	27,100	26,800	26,500	25,300	23,300	20,300	14,500	9,500
1500 (5.18% Z)	# 4	40,050	37,000	33,100	26,000	14,400	8,200	4,000	1,400	600
	# 0	40,050	38,800	36,800	33,200	24,500	16,000	9,200	4,000	2,000
	250 MCM	40,050	39,100	37,800	35,600	29,900	23,000	15,200	7,500	4,000
	2 - 250 MCM	40,050	39,600	39,000	37,900	34,100	29,000	22,500	13,000	7,400
	2 - 500 MCM	40,050	39,700	39,200	38,200	35,500	31,600	25,900	16,400	10,100
2000 (5.17% Z)	# 4	52,800	47,400	40,700	30,000	15,100	8,200	4,200	1,900	1,000
	# 0	52,800	50,200	47,000	42,200	28,000	17,000	9,700	4,200	2,400
	250 MCM	52,800	51,000	49,000	45,400	36,200	26,500	16,500	8,000	4,200
	2 - 250 MCM	52,800	51,800	50,900	48,900	43,100	36,000	26,700	14,000	8,000
	2 - 500 MCM	52,800	52,100	51,300	49,900	45,100	39,200	30,800	18,500	11,000

# SECTION III: 3-PHASE FAULT CURRENT TABLES

Table 4: 3 ø Fault Current Available (symmetrical rms amperes) 600 Volts										
KVA Rating of Transformer	Copper Conductor Size Per Phase	Distance from Transformer to Point of Fault - Feet								
		0	5	10	20	50	100	200	500	1,000
150 (4.19% Z)	# 4	3,990	3,950	3,910	3,850	3,670	3,340	2,710	1,640	960
	# 0	3,990	3,960	3,930	3,880	3,820	3,670	3,360	2,600	1,850
	250 MCM	3,990	3,970	3,950	3,910	3,860	3,780	3,580	3,080	2,430
	2 - 250 MCM	3,990	3,980	3,970	3,940	3,910	3,860	3,760	3,480	3,100
255 (4.17% Z)	# 4	5,980	5,920	5,870	5,740	5,300	4,610	3,500	1,880	1,010
	# 0	5,980	5,940	5,900	5,850	5,640	5,300	4,700	3,820	2,100
	250 MCM	5,980	5,950	5,920	5,890	5,760	5,550	5,150	4,180	3,090
	2 - 250 MCM	5,980	5,960	5,940	5,930	5,860	5,750	5,540	4,920	4,140
	2 - 500 MCM	5,980	5,970	5,960	5,950	5,900	5,820	5,650	5,180	6,420
300 (4.16% Z)	# 4	7,990	7,880	7,800	7,560	6,800	5,560	3,900	2,000	1,050
	# 0	7,990	7,920	7,880	7,740	7,380	6,800	5,800	3,740	2,300
	250 MCM	7,990	7,940	7,910	7,800	7,600	7,200	6,540	5,000	3,500
	2 - 250 MCM	7,990	7,960	7,940	7,850	7,760	7,580	7,200	6,200	5,000
	2 - 500 MCM	7,990	7,980	7,960	7,900	7,840	7,700	7,400	6,600	5,600
500 (4.12% Z)	# 4	13,230	13,000	12,700	12,000	9,980	7,350	4,600	2,000	1,000
	# 0	13,230	13,100	12,960	12,600	11,600	10,180	7,700	4,200	2,400
	250 MCM	13,230	13,130	13,100	12,920	12,300	11,300	9,650	6,400	4,200
	2 - 250 MCM	13,230	13,170	13,130	13,060	12,720	12,180	11,200	9,000	6,580
	2 - 500 MCM	13,230	13,200	13,170	13,120	12,880	12,500	11,700	9,800	7,650
750 (5.19% Z)	# 4	16,360	16,100	15,750	14,800	11,800	8,200	5,000	2,200	1,050
	# 0	16,360	16,200	16,000	15,550	14,200	12,000	8,700	4,800	2,550
	250 MCM	16,360	16,250	16,100	15,800	14,950	13,400	11,200	7,100	4,300
	2 - 250 MCM	16,360	16,350	16,150	16,000	15,600	14,800	13,300	10,200	7,300
	2 - 500 MCM	16,360	16,350	16,200	16,050	15,800	15,000	14,000	11,400	8,700
1000 (5.19% Z)	# 4	21,750	21,100	20,250	18,500	13,800	9,000	5,000	2,200	1,200
	# 0	21,750	21,500	21,000	20,250	17,800	14,400	9,800	4,800	2,550
	250 MCM	21,750	21,570	21,200	20,750	19,300	16,900	13,400	8,000	4,700
	2 - 250 MCM	21,750	21,650	21,500	21,250	20,500	19,200	16,800	12,000	8,200
	2 - 500 MCM	21,750	21,730	21,600	21,400	20,750	19,700	17,900	13,800	10,000
1500 (5.18% Z)	# 4	32,050	30,550	28,700	25,250	16,300	9,600	5,300	2,300	1,200
	# 0	32,050	31,250	29,500	26,800	18,800	12,500	7,000	3,000	1,500
	250 MCM	32,050	31,500	30,800	29,800	26,600	22,250	16,300	8,800	4,800
	2 - 250 MCM	32,050	31,800	31,500	31,000	29,200	26,600	22,800	14,300	8,800
	2 - 500 MCM	32,050	31,900	31,600	31,200	29,800	27,600	29,000	17,200	11,500
2000 (5.17% Z)	# 4	42,200	39,700	36,300	30,000	17,400	10,000	5,100	2,100	1,200
	# 0	42,200	40,900	39,500	36,000	27,800	19,000	11,500	5,000	2,600
	250 MCM	42,200	41,300	40,050	38,100	32,900	26,000	18,000	9,100	5,000
	2 - 250 MCM	42,200	41,700	41,000	40,000	36,900	32,200	25,900	15,800	9,200
	2 - 500 MCM	42,200	42,000	41,300	40,600	38,100	34,200	28,800	19,600	12,500

# SECTION IV: QUICK 3-PHASE SHORT-CIRCUIT CALCULATIONS AND TABLES

Short circuit levels must be known before fuses can be correctly applied. For fuses, unlike circuit breakers, there are only three levels of interest. These are 10,000, 50,000, and 200,000 RMS Symmetrical amperes. The use of Class J or R fuses with 200,000 A interrupting rating, however, eliminates concerns for the lower levels.

Rigorous determination of short circuit currents requires accurate reactance and resistance data for each power carrying component from the utility generating station to the point of the fault. If the information has not been collected ahead of time, this can be a time-consuming process.

The method described here is not new, but it is updated and more comprehensive than before and is the simplest of all approaches.

In summary, each basic component of the industrial electrical distribution system is pre-assigned a

single factor based on the impedance it adds to the system. For instance, a 1000KVA, 480 volt, 5.75%Z transformer has a factor of 4.80. This factor corresponds with 25,000 RMS short circuit amperes. (directly read on Scale 1 on page 25.)

Note: Factors change directly with transformer impedance. If this transformer were 5.00%Z, the factor would be  $5.00/5.75 \times 4.80 = 4.17$ .

Cable and bus factors are based on 100 foot lengths, shorter or longer lengths have proportionally smaller or larger factors (i.e. 50' length = 1/2 factor; 200' length = 2 x factor).

To find the short circuit current at any point in the system, simply add the factors as they appear in the system from the entrance to the fault point and read the available current on Scale 1, page 25. The short circuit current can also be determined from the factor by dividing 120,000 by the factor.

Example 1: What is the potential short circuit current at various points in a 480V, 3-phase system fed by a 1000 KVA, 5.75%Z transformer? (Assume primary short circuit power to be 500 MVA.)

Answer:

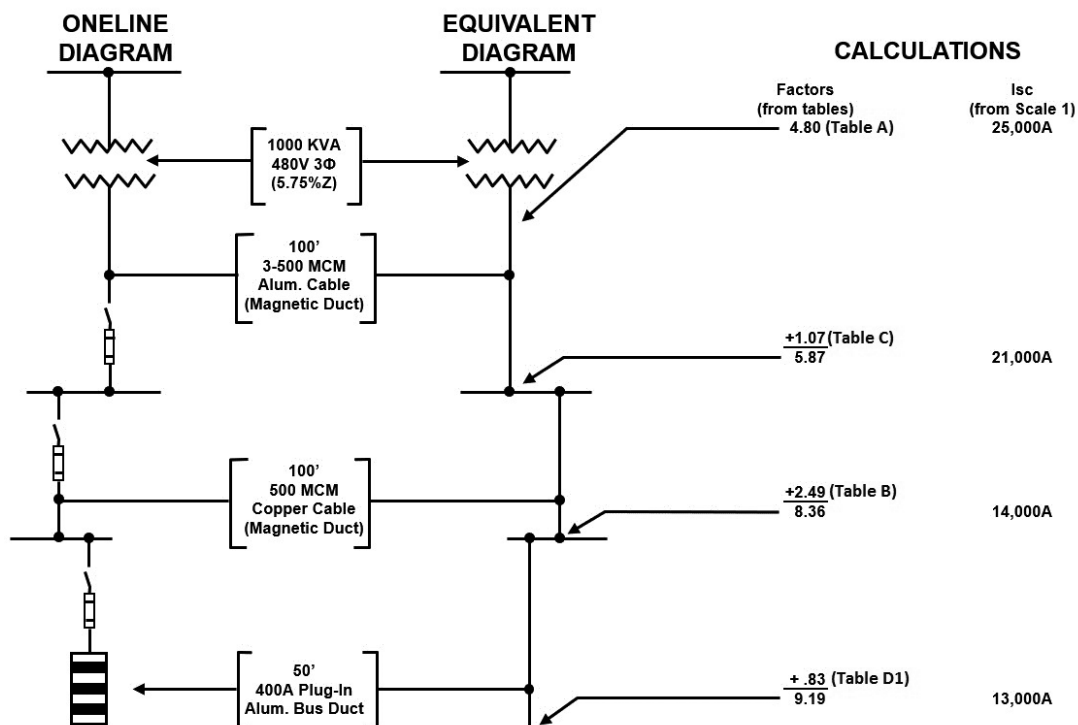

FIG. IV-1

# SECTION IV: QUICK 3-PHASE SHORT-CIRCUIT CALCULATIONS AND TABLES

## QUICK 3-PHASE SHORT CIRCUIT TABLES

### Factors

#### A. Transformers – 3Ø

(Transformer factors are based on available primary short circuit power of 500MVA.)

Table A: Three-phase Transformer factors					
Transformer		Factor 3 Phase Voltage			
KVA	%Z	208V	240V	480V	600V
75	1.6	9	10	20	24
100	1.7	7	8	16	20
112.5	2	7.4	8.5	17	21
150	2	5.4	6	12	15
225	2	3.7	4	8	10
300	2	2.7	3	6	7.5
500	2.5	2.15	2.25	4.5	5.6
750	5.75	2.78	3.25	6.5	8
1000	5.75	2.24	2.4	4.8	6
1500	5.75	1.48	1.6	3.2	4
2000	5.75	NA	1.2	2.4	3
2500	5.75	NA	0.95	1.91	2.4

#### A1. Transformer correction factors

For systems with less than 500 MVA primary short circuit power, add the appropriate correction factors in this table to the transformer factor.

Table A1: Transformer Correction Factors				
Primary MVA	Factor 3 Phase Voltage			
	208V	240V	480V	600V
15	2.82	3.24	6.43	8.05
25	1.65	1.9	3.78	4.73
50	0.78	0.9	1.74	2.24
100	0.34	0.4	0.8	1
150	0.2	0.23	0.46	0.58
250	0.08	0.1	0.2	0.25
Infinite	-0.08	-0.1	-0.2	-0.25

**Example 2:** If the primary short circuit power were 50MVA (instead of 500 MVA) in this same system, what would the Isc be at the transformer? At the end of the bus duct run?

**Answer:** From the Primary MVA correction factor table above (Table A1), the factor for 50MVA (at 480V) is 1.74. The new factor at the transformer is  $4.80 + 1.74 = 6.54$  and Isc is reduced to 18,000A. The new Factor at the bus duct is  $9.67 + 1.74 = 11.41$  and Isc is 11,000A.

#### NOTES:

- 208 volt transformer factors are calculated for 50% motor load.
- 240, 480 and 600 volt transformer factors are calculated for 100% motor load.
- A phase-to-phase fault is .866 times the calculated 3-phase value.

#### A2. Second 3Ø Transformer In System

1. Determine System Factor at the second transformer primary.  
**Example:**  $I_{sc} @ 480v = 40,000A$ . Factor is 3.00 (from Scale 1, P. 25)
2. Adjust factor in proportion to voltage ratio of 480/208V Transformer  
**Example:** For 208V, Factor changes to  $(208 \div 480) \times 3.00 = 1.30$
3. Add factor for second 3-phase transformer.  
208V 14,500A  
**Example:** Factor for 100KVA, 208v, 1.70%Z Transformer is 7.00 (from Table A)  
Total Factor =  $7.00 + 1.30 = 8.30$  (Isc = 14,500A)

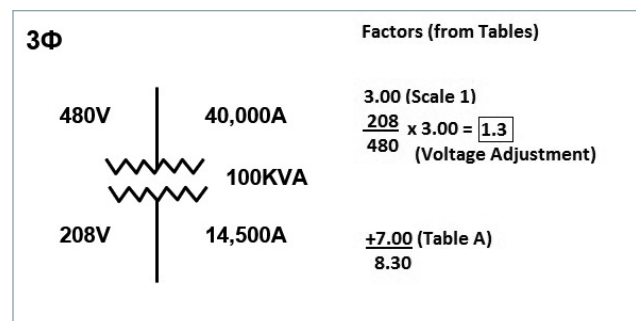

FIG. IV-2

# SECTION IV: QUICK 3-PHASE SHORT-CIRCUIT CALCULATIONS AND TABLES

## A3. Single Phase Transformer in 3ø System

Transformer connections must be known before factor can be determined.

See Figures IV-3 and IV-4.

- Determine system factor at 1-phase transformer primary, with 480v primary, 120/240v secondary (Figure A)

**Example:**  $I_{sc}$  @ 480v = 40,000A, 3ø.

Factor is 3.00 (from P. 24)

$$1\phi \text{ Factor} = \frac{3\phi \text{ Factor}}{.866} = \frac{3.00}{.866} = 3.45$$

- Adjust Factor in proportion to voltage ratio of 480/240V transformer.

**Example:** For 240v, 1ø, factor is:

$$\frac{240}{480} \times 3.45 = 1.70$$

- Add Factor 1ø transformer (from Table A3) with Figure IV-3 connection.

Example: Factor for 100KVA, 120/240v, 3%Z transformer is:

a. 120v - Total factor = 6.22 + 1.70 = 7.92 (Isc = 15,000A)

b. 240v - Total factor 8.64 + 1.70 = 10.34 (Isc = 11,600A)

NOTE: Factor varies with %Z

**Example:** 50KVA, 240V secondary with a 1.5%Z has a factor of  $(1.5\%Z \div 3.0\%Z) \times 17.3 = 8.65$

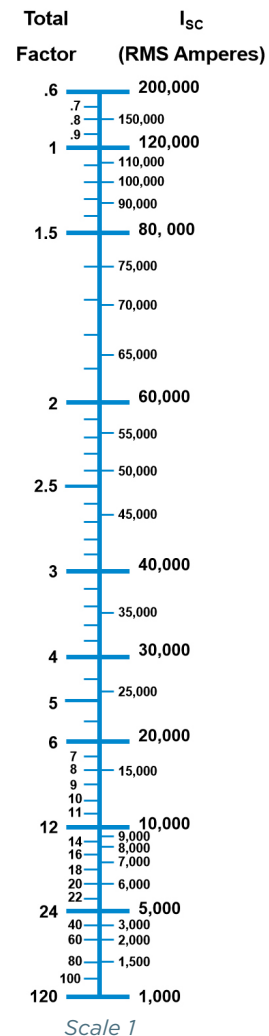
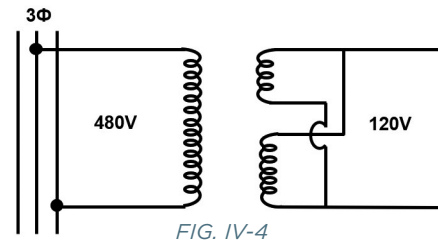
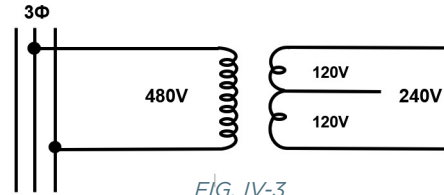

Table A3: Transformers – 1 Phase				
Transformer		Factor 3 Phase Voltage		
KVA	%Z	120V Fig. A	240V Fig. A	120V Fig. B
15	2.5	34.6	48	24
25	2.5	20.7	28.8	14.4
37.5	2.8	16.6	23	11.5
50	3	12.5	17.3	8.65
75	3	8.28	11.5	5.75
100	3	6.22	8.64	4.32
150	2.5	3.46	4.8	2.4
167	2.5	3.1	4.31	2.16
225	2.5	2.3	3.2	1.6
300	3	2.07	2.88	1.44
500	4.5	1.86	2.59	1.3

# SECTION IV: QUICK 3-PHASE SHORT-CIRCUIT CALCULATIONS AND TABLES

**Table B. Copper Cables in Magnetic & Non-Magnetic Duct {per 100'}**

Cable Size	B - Magnetic Duct				B1 - Non-Magnetic Duct			
	3 Phase Voltage				3 Phase Voltage			
	208V	240V	480V	600V	208V	240V	480V	600V
#8	79	68	34	27	78	67.6	33.8	27.1
#6	50	43	22	17.5	47.9	41.5	20.7	16.6
#4	32	28	14	11.15	30.7	26.7	13.3	10.7
#2	21	18	9	7.23	19.9	17.2	8.61	6.89
#1	17.5	15	7.4	5.91	16.2	14	7.07	5.6
1/0	14	12.2	6.1	4.85	13.2	11.4	5.7	4.57
2/0	11.8	10.2	5.1	4.05	10.6	9.21	4.6	3.68
3/0	9.8	8.5	4.27	3.43	8.87	7.59	3.85	3.08
4/0	8.4	7.3	3.67	2.94	7.57	6.55	3.28	2.62
250 MCM	7.7	6.7	3.37	2.7	6.86	5.95	2.97	2.38
300 MCM	7	6.1	3.04	2.44	5.75	4.98	2.49	1.98
350 MCM	6.6	5.7	2.85	2.28	5.36	4.64	2.32	1.86
400 MCM	6.2	5.4	2.7	2.16	5.09	4.41	2.2	1.75
500 MCM	5.8	5	2.49	2	4.66	4.04	2.02	1.62
600 MCM	5.5	4.8	2.4	1.91	4.29	3.72	1.86	1.49
750 MCM	5.2	4.5	2.26	1.8	4.05	3.51	1.76	1.41

For parallel runs at 250 through 750MCM divide factor by conductors per phase.  
 Example: 3-500MCM per phase, 480v. New Factor =  $(2.49 \div 3) = .83$

**Table C. Aluminum Cables in a Magnetic Duct [per 100']**

Cable Size	B - Magnetic Duct				B1 - Non-Magnetic Duct			
	3 Phase Voltage				3 Phase Voltage			
	208V	240V	480V	600V	208V	240V	480V	600V
#8	129	112	56	45	129.75	112.45	56.2	45
#6	83	72	36	29	80	69.1	34.6	27.7
#4	53	46	23	18.5	51.1	44.2	22.1	17.7
#2	35	30	15	12	33	25.7	14.3	11.4
#1	28	24	12	9.5	26.3	22.8	11.4	9.12
1/0	21.5	18.5	9.7	7.7	21.2	18.4	9.2	7.36
2/0	18.5	16	8	6.4	17	14.7	7.34	5.87
3/0	15	13	6.5	5.2	13.8	12	6.02	4.79
4/0	12.5	11	5.5	4.4	11.5	9.95	4.98	3.99
250 MCM	11.1	9.6	4.8	3.85	10.1	8.72	4.36	3.49
300 MCM	9.9	8.6	4.3	3.42	8.13	7.04	3.52	2.81
350 MCM	8.6	7.4	3.7	3	7.49	6.5	3.07	2.45
400 MCM	8.3	7.2	3.6	2.9	6.87	5.95	2.98	2.38
500 MCM	7.4	6.4	3.2	2.6	6.12	5.31	2.66	2.13
600 MCM	7.2	6.2	3.1	2.44	5.3	4.59	2.29	1.83
750 MCM	6.5	5.6	2.8	2.22	4.85	4.2	2.1	1.69



# SECTION IV: QUICK 3-PHASE SHORT-CIRCUIT CALCULATIONS AND TABLES

**Table D. Factors for Feeder\* Bus Duct [Per 100']**

Duct Ampere Rating	3 Phase Voltage							
	Copper				Aluminum			
	208V	240V	480V	600V	208V	240V	480V	600V
600	2.85	2.48	1.24	0.99	2.54	2.19	1.1	0.88
800	1.61	1.4	0.7	0.56	2.54	2.19	1.1	0.88
1000	1.61	1.4	0.7	0.56	1.9	1.65	0.82	0.66
1200	1.21	1.06	0.53	0.42	1.6	1.36	0.66	0.54
1350	1.17	1.01	0.51	0.4	1.32	1.14	0.57	0.46
1600	1.03	0.89	0.45	0.36	1.19	1.03	0.52	0.41
2000	0.9	0.78	0.39	0.31	0.9	0.77	0.39	0.31
2500	0.63	0.54	0.27	0.22	0.7	0.6	0.3	0.24
3000	0.51	0.44	0.22	0.18	0.6	0.52	0.26	0.21
4000	0.37	0.32	0.16	0.13	0.43	0.38	0.19	0.15
5000	0.3	0.26	0.13	0.1	--	--	--	--

\* These factors may be used with feeder duct manufactured by I-T-E, GE, Square D and Westinghouse.

**Table D1. Factors for Plug-In\*\* Bus Duct [Per 100']**

Duct Ampere Rating	3 Phase Voltage							
	Copper				Aluminum			
	208V	240V	480V	600V	208V	240V	480V	600V
400	2.53	2.18	1.09	0.89	3.88	3.34	1.67	1.36
600	2.53	2.18	1.09	0.89	2.41	2.07	1.04	0.84
800	1.87	1.61	0.81	0.66	2.41	2.07	1.04	0.84
1000	1.87	1.61	0.81	0.66	1.69	1.45	0.73	0.59
1200	1.47	1.26	0.63	0.51	1.43	1.22	0.61	0.5
1350	1.26	1.08	0.54	0.44	1.3	1.12	0.56	0.45
1600	0.91	0.78	0.39	0.32	1.09	0.94	0.47	0.38
2000	0.79	0.68	0.34	0.28	0.89	0.77	0.38	0.31
2500	0.61	0.52	0.26	0.21	0.66	0.57	0.28	0.23
3000	0.48	0.42	0.21	0.17	0.59	0.51	0.25	0.21
4000	0.43	0.37	0.18	0.15	0.46	0.4	0.2	0.16
5000	0.38	0.33	0.16	0.13	0.35	0.3	0.15	0.12

\*\* These factors may be used with feeder duct manufactured by I-T-E, GE, Square D and Westinghouse.

## SECTION V: FUSE CLASSIFICATIONS AND SPECIFICATIONS

### UNDERWRITERS LABORATORIES INC.

UL listed cartridge fuses are tested on AC and are marked either “250 Volt AC or Less” or “600 Volt AC or Less.” These fuses should be used on DC applications only if recommended by manufacturer as suitable for DC use.

The following are some of the major UL listings for fuses:

**UL Class J, K, L, R and CC** — these fuses are tested at several different available currents and must meet other UL requirements before being assigned a specific interrupting rating.

Further, Class J, L, R and CC fuses have unique dimensions or rejection features which meet the non-interchangeability requirement of the NEC for current-limiting fuses. As a result, these fuses provide a significant increase in equipment and personnel protection over the older, underrated Class H fuses.

The popular Mersen Amp-trap 2000® family was selected from Class J, L, RK1 and CC fuses with time delay because they have the best credentials for industrial use. Properly applied, these fuses can give “no damage” protection to equipment.

**UL Class H** — fuses in this class are tested on a 10,000 ampere short-circuit. This is not considered an interrupting rating by UL but is by the National Electrical Code. “Renewable” fuses comprise the fuse types in this class. Also, NEC only allows renewable fuses to be “used for replacement in existing installations where there is no evidence of overfusing or tampering.” (Note: Mersen One-Time fuses are UL Class K-5, with an Interrupting Rating of 50,000 amperes.)

It should be noted that fuses are single-phase devices and any one of three fuses on a three-phase fault may see the worst current condition, ie: asymmetrical current - approximately 2.4 times the symmetrical current. For this reason,

the Underwriters Laboratories tests fuses on ‘controlled closing’ (see page 12). Some low voltage fuse standards require investigating all “degrees of asymmetry.” This is not practical, so a few critical conditions are specified by UL.

### POINTS OF INTEREST

1. There may frequently be need for current-limiting fuse characteristics on circuits which cannot deliver more than 10,000 amperes. In these cases, current-limiting fuses with interrupting ratings of 200,000 amperes are used for reasons other than their interrupting ability. For example, a 200,000-ampere interrupting capacity current limiting fuse can be used to provide overcurrent protection to downstream components whose SCCR is less than 10,000 amperes. (i.e.: Utilizing the current-limiting ability of the fuse to protect a motor controller with a 5,000 ampere SCCR).
2. There are many current-limiting fuses in existence with Class H and K dimensions, with interrupting ratings of 50,000, 100,000 or 200,000 amperes. These cannot be marked current limiting because they are interchangeable with non-current-limiting fuses. Utilizing UL Class R or J for these applications eliminates this problem and ensures protection for the electrical distribution system.
3. In order that a fused switch may have a rating of greater than 10,000A (i.e.: 100,000A or 200,000A) it must be fitted with rejection clips that accept only Class R, J or CC fuses. This assures that lower rated, less current-limiting fuses are not installed into the switch which could jeopardize the switch capacity.
4. The tables in Section III show where fuses or circuit breakers of various interrupting ratings should be used. These charts give symmetrical short-circuit currents. UL listed fuses can be selected by matching their interrupting rating with the available currents shown in any of these tables. Fuses without marked interrupting ratings (One-Time and Renewable Class H) can only be used for conditions below 10,000 amperes.

# SECTION V: FUSE CLASSIFICATIONS AND SPECIFICATIONS

When circuit breaker interrupting ratings are compared with the tables, conditions will arise where the breaker rating will be inadequate for the available short-circuit current shown. Further discussion and application on this topic is given in the Mersen bulletin “Fuse Protection of Molded-Case Circuit Breakers.”

## AMP-TRAP® 2000 SUGGESTED FUSE SPECIFICATIONS

### 1.0 General

The electrical contractor shall furnish and install a complete set of fuses for all fusible equipment on the job as specified by the electrical drawings. Final tests and inspections shall be made prior to energizing the equipment. This shall include tightening all electrical connections and inspecting all ground conductors. Fuses shall be as follows:

### 2.0 Mains, Feeders and Branch Circuits

- A. Circuits 601 to 6000 amperes shall be protected by current-limiting Mersen Amp-Trap 2000 Class L time-delay A4BQ fuses. Fuses shall be time-delay and shall hold 500% of rated current for a minimum of 4 seconds, clear 20 times rated current in .01 second or less and be UL listed and CSA certified with an interrupting rating of 200,000 amperes rms symmetrical.
- B. Circuits 600 amperes or less shall be protected by current-limiting Mersen Amp-Trap 2000 Class RK1 time-delay A2D (250V) or A6D (600V) or Class J time-delay AJT fuses. Fuses shall hold 500% of rated current for a minimum of 10 seconds (30A, 250V Class RK1 case size shall be a minimum of 8 seconds) and shall be UL listed and CSA certified with an interrupting rating of 200,000 amperes rms symmetrical.
- C. Motor Protection: All individual motor circuits shall be protected by Mersen Amp-Trap 2000 Class RK1, Class J or Class L time-delay fuses as follows:

For circuits up to 480A	Class RK1 - A2D (250V) or A6D (600V)
	Class J - AJT
For circuits over 480A	Class L - A4BQ

Fuse sizes for motor protection shall be chosen from tables published by Mersen for the appropriate fuse. Heavy load and maximum fuse ratings are also shown for applications where typical ratings are not sufficient for the starting current of the motor.

- D. Motor Controllers: Motor controllers shall be protected from short circuits by Mersen Amp-Trap 2000 time-delay fuses. For IEC style controllers requiring Type 2 protection, fuses shall be chosen in accordance with motor control manufacturers published recommendations, based on Type 2 test results. The fuses shall be Class RK1 A2D (250V) or A6D (600V) or Class J AJT or Class CC ATDR (600V).
- E. Circuit breakers and circuit breaker panels shall be protected by Mersen Amp-Trap 2000 fuses Class RK1 (A2D or A6D), Class J (AJT) or Class L (A4BQ) sized in accordance with tested UL Series-Connected combinations published in the current yellow UL Recognized Component Directory.
- F. Lighting and control circuits in the connected combinations shown up to 600Vac shall be protected by Mersen Amp-Trap 2000 Class CC time-delay ATDR fuses, sized according to the electrical drawings.

### 3.0 Spares

Spare fuses amounting to 10% (minimum three) of each type and rating shall be supplied by the electrical contractor. These shall be turned over to the owner upon project completion. Fuses shall be contained and cataloged within the appropriate number of spare fuse cabinets (no less than one), located per project drawings. Spare fuse cabinets

## SECTION V: FUSE CLASSIFICATIONS AND SPECIFICATIONS

shall be equipped with a key lock handle, be dedicated for storage of spare fuses and shall be GSFC, as supplied by Mersen.

### 4.0 Execution

- A. Fuses shall not be installed until equipment is to be energized. All fuses shall be of the same manufacturer to assure selective coordination.
- B. As-installed drawings shall be submitted to the engineer after completion of the job.
- C. All fusible equipment rated 600 amperes or less shall be equipped with fuse clips to accept Class RK1 or Class J fuses as noted in the specifications.

### 5.0 Substitution

Fuse sizes indicated on drawings are based on Mersen Amp-Trap 2000 fuse current-limiting performance and selectivity ratios. Alternative submittals to furnish materials other than those specified, shall be submitted to the engineer in writing two weeks prior to bid date, along with a short circuit and selective coordination study.

Product	Catalog No.	AC Volts	Ampere Rating	Electrical Standard	Int. Rating RMS Amps	Applications
Amp-Trap 2000® Class J Time-Delay	AJT	600	1-600	J	200000	Feeder circuits, motor overcurrent protection.
Amp-Trap 2000® Class L 4-Second Delay	A4BQ	600 (500 VDC)	601-6000 601-3000	L	200000	The most current-limiting of all Class [fuses for service entrance and all high current applications.
Amp-Trap 2000® Time-Delay Class RK1	A2D (Amp) R A6D (Amp) R	250 600	1/10 - 600	RK1	200000	Transformer, motor controller and motor overcurrent protection. Increased current limitation.
Amp-Trap 2000® Class CC Time-Delay	ATDR	600	1/4 to 30	CC	200000	Branch circuit protection for motor circuits.
Tri-Onic® Time-Delay	TR (Amp) R TRS (Amp) R	250 600	1/10 - 600	RK5	200000	Transformer, motor controller and motor overcurrent protection. High inrush inductive loads.
Amp-Trap® Class RK1	A2K (Amp) R A6K (Amp) R	250 600	1-600	RK1	200000	Service entrance equipment, feeder circuits and circuit breaker back-up protection.
Amp-Trap® Class J	A4J	600	1-600	J	200000	Feeder circuits, panelboards and circuit breaker back-up protection.
Amp-Trap® Class T	A3T A65	300 600	1 - 800 1- 1200	T	200000	Feeder circuits, panelboards and circuit breaker back-up protection.
Amp-Trap® Class G	AG	600 480	1/2-20 25-60	G	100000	Branch circuit protection for lighting, heating, and appliance circuits.
Amp-Trap® Class L	A4BY	600	601-6000	L	200000	Service entrance equipment, feeder circuits and circuit breaker back-up protection.
Amp-Trap® Class L Time-Delay	A4BT	600	601-2000	L	200000	Protection of large motors and motor controllers.
Amp-Trap® Form 600	A2Y A6Y	250 600	1-1200	*N.A	200000	Back-up protection for fusible equipment and circuit breakers.
One-Time	OT OTS	250 600	1-600	K5	50000	Switches, panelboards, service entrance, electric heat. Limited to 50kA fault.
Renewable	RF RFS	250 600	1-600	H	10000	Switches and fusible equipment. Limited to 10kA fault current

# SECTION V: FUSE CLASSIFICATIONS AND SPECIFICATIONS

Product	Catalog No.	AC Volts	Ampere Rating	Electrical Standard	Int. Rating RMS Amps	Applications
Amp-Trap® Form 101	A13X, A13Z, 125X, A25Z, A60X, A60Z, A50P, A50QS, A70P, A70Q, A100P, A120P, A150P	130 150 600 500 700 1000 1200 1500	1-6000 1-4500 1-2000 10-1200 10-1000 15-1000 45-800 35-800	Many Sizes Recognized Components	Various to 200,000	Protection for Semiconductors, rectifiers, diodes, SCR, D.C. power supplies, inverters, U.P.S. systems, controls, variable speed drives, mine power supplies and special applications, A.C. or D.C.
E-Rated	A055 A155	5,500 15,500	5E-900E 5E-300E	UL Listed	63,000 50,000	Power and distribution transformer primary overcurrent protection.
R-Rated	A240R A480R-a A072	2400 4800 7200	2R-36R	Recognized Component	70,000 100,000 80,000	
Amp-Trap® Cable Protector	CP	700	40-750MCM Cable	N/A	200000	Copper or Aluminum Cables
Glass & Miniature	GSR-V, GGM, GGX, GSC, GGC, GDL, GSB, GDG, GAB, GGA-V	Various	1/100-30	Miniature	Various	Time-delay and nontime-delay protection of electrical and electronic circuits.
Midgets	ATMR, A6Y-2B, ATM, ATQ, OTM, TRM, GFN, GGU	Various	1/10 to 30	CC & Miniature	Various	Small motors, current transformers and signal circuits.
In-Line Fuse Holders	FEB, FEX FEC, FEY FEG	600	30 30 60	Midget CC G	100,000-Midget 200,000-CC 100,000-G	Choice of crimp or set-screw for in-line cables. Optional breakaway feature.
Fuse Blocks	20, 21, 22, 24, 26, 60.61, 62, 64, 66 Series	250 600	30-600	H J K R	10,000 200,000 50,000 200,000	All Class H, J, K, & R Applications
Midget Fuse Blocks	30 Series	600	30	For Midget & CC Fuses	200,000-CC 10,000-Midget	All Midget and Class CC Fuse Applications
Ultra-Safe Fuse Blocks	USM USCC USJ	600	30 30 60	Midget CC J		All Midget, Class CC, and Class J Fuse Applications
Power Distribution Blocks	62, 63, 66, 67, 68, 69 Series	600	90-1440	Listed Component	*N.A.	Power terminals for multiple tapping or splitting of conductors to distribute power in commercial and industrial applications.



## MERSEN'S PRODUCT RECOGNITION APP

Mersen's App lets you:

- Search for a product via Photo or Text
- Identify Mersen and competitive products
- Locate Sales Reps
- Use motor and transformer tables to look up products

Mersen's Product Recognition App is available for download from the App Store or Google Play.



[Scan code below to go to the App Store](#)



[Scan code below to go to Google Play](#)





MERSEN IS A GLOBAL EXPERT  
IN ELECTRICAL POWER AND  
ADVANCED MATERIALS

#### NORTH AMERICA

**USA**  
Mersen USA  
374 Merrimac Street  
Newburyport, MA 01950  
T : 978 462 6662

**CANADA**  
Mersen Canada  
6200 Kestrel Road  
Mississauga, ON L5T 1Z1  
T : 416 252 9371

#### EUROPE

**FRANCE**  
Mersen France SB S.A.S.  
15 rue Jacques de Vaucanson  
F-69720 Saint-Bonnet-de-Mure  
T : +33 4 72 22 66 11

#### ASIA

**CHINA**  
Mersen Shanghai  
No.55-A6. Shu Shan Road  
Songjiang 201611 Shanghai  
T : +8621 67602388



[EP.MERSEN.COM](http://EP.MERSEN.COM)